



67-75 Lords Road, Leichardt Traffic and Parking Impact Assessment

Prepared for:
Platino Properties

2 August 2022

The Transport Planning Partnership

67-75 Lords Road, Leichardt

Traffic and Parking Impact Assessment

Client: Platino Properties

Version: V06

Date: 2 August 2022

TTPP Reference: 18145

Quality Record

Version	Date	Prepared by	Reviewed by	Approved by	Signature
V01	10/06/22	Ashwini Uthishtran	Oasika Faiz	Ken Hollyoak	DRAFT
V02	01/07/22	Ashwini Uthishtran	Oasika Faiz	Ken Hollyoak	Final
V03	14/07/22	Oasika Faiz	Oasika Faiz	Ken Hollyoak	Final
V04	21/07/22	Oasika Faiz	Oasika Faiz	Ken Hollyoak	Final
V05	29/07/22	Oasika Faiz	Oasika Faiz	Ken Hollyoak	Final
V06	02/08/22	Oasika Faiz	Oasika Faiz	Ken Hollyoak	

Table of Contents

1	Introduction	1
1.1	Background.....	1
2	Existing Conditions	2
2.1	Site Description	2
2.2	Abutting Road Network.....	4
2.2.1	Lords Road.....	4
2.2.2	Foster Street	4
2.2.3	Tebbutt Street	5
2.3	Public Transport Services.....	5
2.3.1	Train	5
2.3.2	Light Rail	6
2.3.3	Bus Services.....	6
2.4	Pedestrian and Cyclist Facilities.....	7
2.5	Traffic volumes	9
2.6	Strategic Context	11
2.6.1	Parramatta Road Corridor Precinct-Wide Traffic and Transport Study	11
2.6.2	Inner West Traffic and Transport Needs Study	12
3	Proposed Development.....	14
3.1	Proposal Description	14
3.2	Vehicle Access and Circulation	14
3.3	Pedestrian Connectivity	15
4	Parking Assessment.....	16
4.1	Car Parking Requirement	16
4.1.1	Leichardt DCP 2013	16
4.1.2	PRCUTS	17
4.1.3	Housing SEPP.....	17
4.1.4	TFNSW Traffic Generation Studies	18
4.1.5	Summary of Car Parking Assessment	18
4.2	Bicycle Parking Requirement	19
4.3	Motorcycle Parking Requirement.....	19
4.4	Loading Requirement	19
4.5	Parking Layout Design Requirements	20
5	Traffic Generation.....	21
5.1	Existing Site Traffic Generation	21

5.1.1	Traffic generation based on RMS Rates.....	21
5.1.2	Traffic Generation Based on Survey Data	21
5.2	Proposed Development Site Traffic Generation.....	27
5.3	Summary of Traffic Analysis	28
6	Green Travel Plan	30
6.1	Overview	30
6.2	Transport Plan Framework	30
6.3	Types of Travel Plans.....	30
6.4	Green Travel Plan Initiatives	31
6.5	Case Study – Harold Park Green Travel Plan	32
7	Conclusions	34

Tables

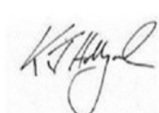
Table 2.1:	Existing Tenancy Breakdown.....	3
Table 2.2:	Summary of Existing Train Services and Frequencies	5
Table 4.1:	Leichhardt DCP 2013 Car Parking Requirements	16
Table 4.2:	PRCUTS Development Parking Requirements	17
Table 4.3:	TfNSW Servicing and Loading Recommendations.....	19
Table 5.1:	Traffic Generation of Existing Land Uses	21
Table 5.2:	Net Proposed Development Traffic Estimates	28
Table 6.1:	Summary of Harold Park Post-Occupation Surveys	33

Figures

Figure 2.1:	Site Locality	2
Figure 2.2:	Aerial Image of Existing Site	4
Figure 2.3:	L1 Dulwich Hill Light Rail Route	6
Figure 2.4:	Existing Bus Network Map	7
Figure 2.5:	Existing Pedestrian (Zebra) Crossings	8
Figure 2.6:	Existing Bicycle Route Map.....	9
Figure 2.7:	Existing Peak Hour Traffic Volumes	10
Figure 2.8:	Key Nominated Intersections	11
Figure 3.1:	Vehicle Access on Ground Level	15
Figure 5.1:	Western Site Access Count (AM).....	23
Figure 5.2:	Western Site Access Count (PM)	24

Figure 5.3: Eastern Site Access Count (AM)	25
Figure 5.4: Eastern Site Access Count (PM).....	26
Figure 5.5: 2018 Existing Site Traffic Generation Profile	27

APPENDICES

A. ARCHITECTURAL PLANS

1 Introduction

1.1 Background

This traffic and parking assessment report has been prepared by The Transport Planning Partnership (TPPP) on behalf of Platino Properties to accompany a Planning Proposal to be lodged with the Inner West Council (Council) seeking approval to construct a mixed-use development located at 67-75 Lords Road, Leichardt.

The Planning Proposal seeks to align with the recommendations of the *Parramatta Road Corridor Urban Transformation Strategy 2016* (PRCUTS) published by the NSW Department of Planning, Industry and Environment, and aims to rezone the site to R3 Medium Density Residential, increase the Floor Space Ratio (FSR) to 1:2.4 and apply a maximum building height of 30m.

The proposal involves the construction of a mixed-use development, comprising 220 residential apartments (including 160 affordable housing units and 60 independent seniors living units) and a minimum of 2,000m² of commercial floor space.

The proposed development is expected to have a lower traffic generation potential than the approved development on-site, as further discussed in Section 5.

This report assesses the traffic implications associated with the proposed rezoning of the site.

The remainder of the report is set out as follows:

- Chapter 2 discusses the existing conditions including a description of the subject site
- Chapter 3 provides a brief description of the proposed development
- Chapter 4 assesses the proposed on-site parking provision and internal layout
- Chapter 5 examines the traffic generation of the proposed development
- Chapter 6 suggests green travel plan initiatives
- Chapter 7 presents the conclusions of the assessment.

2 Existing Conditions

2.1 Site Description

The subject site is located at 67-75 Lords Road, Leichhardt, and falls within the local government area of the Inner West Council. The site is generally bound by Lords Road to the south, a laneway to the east, Lambert Park to the north and the light rail corridor to the west. Notably, the site is located directly south of the Marion light rail stop, which services the L1 Dulwich Hill Line.

The site locality is shown in Figure 2.1.

Figure 2.1: Site Locality

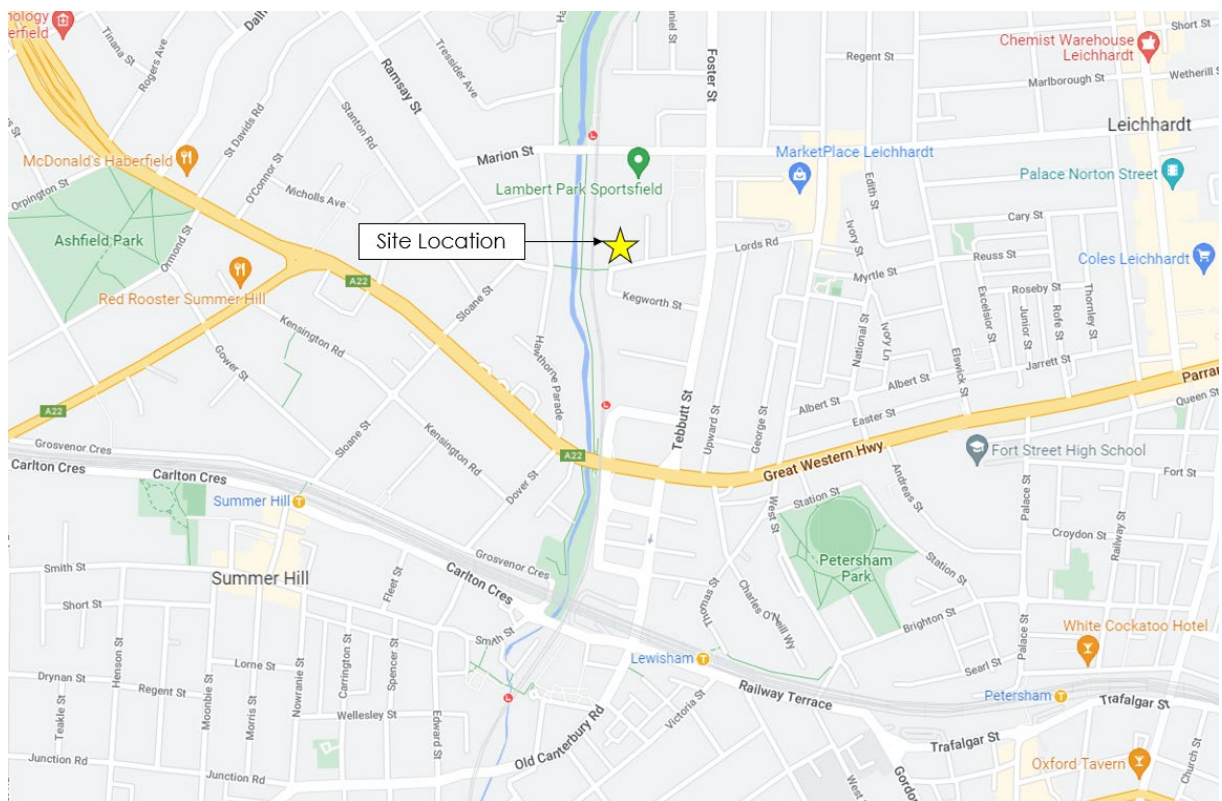

Source: Google Maps Australia (accessed 8/06/22)

At present, the site area is zoned as IN2 Light Industrial in accordance with the Leichhardt Local Environmental Plan (LEP) 2013 and is currently occupied by a number of industrial/warehouse, recreational and commercial tenancies, including a gymnasium, with a combined floor space of just under 10,000m². A summary of the existing tenancy breakdown is provided in Table 2.1.

Table 2.1: Existing Tenancy Breakdown

Land Use	Current or Previous Tenant Activity	Area (m ²)	Tenancy Status
Gymnasium	Gymnasium	1,234	Vacant
Office/ Community	Art School	369	Vacant
Office/ Community	Pottery classes	165	Vacant
Office/ Community	Kung Fu Classes	378	Occupied
Office/ Community	Offices	480	Occupied
Factory	Factory	369	Vacant
Factory	Stage Set Construction	1,905	Occupied
Factory	Engineering	369	Occupied
Factory	Aluminium framing storage	355	Vacant
Warehouse	Warehouse	370	Occupied
Warehouse	Warehouse	1,239	Vacant
Factory	Cardboard Recycling	300	Occupied
Factory	Display furniture & furnishings storage	369	Vacant
Factory	Market food storage	300	Vacant
Factory	Joinery	485	Occupied
Factory	Joinery	369	Occupied
Factory	Builders storage	185	Occupied
Factory	Concrete sealing materials storage	369	Occupied
Factory	Manufacturing	369	Vacant
Total		9,979	-

In addition to this, vehicle access to the site is currently provided via two separate driveways on Lords Road to provide access to two separate car park areas, containing some 120 car spaces. An aerial photograph of the site is shown in Figure 2.2.

Land uses surrounding the site predominately comprise low density residential, retail and light industrial on Lords Road, Foster Street and Tebbutt Street. Kegworth Public School is located 100m south-east of the site. However, as part of the Parramatta Road Corridor Urban Transformation Strategy 2016 (PRCUTS), it is envisaged that the area will be transformed over the next 30 years to provide increased housing, economic activity and social infrastructure, including 27,000 new homes and 50,000 new jobs.

Figure 2.2: Aerial Image of Existing Site



Source: Nearmap Australia (aerial image dated 17/05/22)

2.2 Abutting Road Network

2.2.1 Lords Road

Lords Road functions as a two-way local road, aligned in an east-west direction. It has a posted speed limit of 50km/h, with 40km/h school zone restrictions that apply during school hours. The road provides east-west connectivity between Flood Street and Kegworth Street. In addition to this, vehicle access to the site is currently provided off Lords Road via two driveways. Within the immediate vicinity of the site, unrestricted kerbside parking is generally provided on both sides of the road.

2.2.2 Foster Street

Foster Street is a two-way State road, generally aligned in a north-south direction. The street provides good connectivity to the wider arterial road network, including Parramatta Road and City West Link to the south and north ends respectively, via Darley Road and Tebbutt Street. Notably, at the intersection of Foster Street and Lords Road, no right-turn movements from Foster Street (north leg) into Lords Road (west leg) are permitted.

The street is generally configured with one lane in each direction with kerbside parallel parking on either side of the street. The speed limit is posted as 50km/h, with 40km/h school zone restrictions applicable during school hours within the immediate vicinity of Kegworth Public School.

2.2.3 Tebbutt Street

Tebbutt Street operates as a two-way State road that extends between Foster Street and Parramatta Road in a north-south alignment. The street is generally aligned with one lane in either direction, with kerbside car parking provided on either side of the street. Similar to Foster Street, the posted speed limit of 50km/h, with 40km/h school zone restrictions applicable during school hours. Notably, at the intersection of Tebbutt Street and Parramatta Road, left in and left out restrictions apply into and out of Tebbutt Street.

2.3 Public Transport Services

The site is well serviced by public transport services being located within the immediate vicinity to the Marion light rail stop and a number of bus routes in the area, including bus routes along Marion Street and Parramatta Road. Further to this, the site is located within an 800m radius catchment (or an 850m walking distance) from the Summer Hill railway station.

2.3.1 Train

Train services are provided at Summer Hill and Lewisham Stations which are located directly south-west and south-east of the site respectively. These railway stations service the T2 Inner West & Leppington line and T3 Bankstown line, which provide good connectivity to the Sydney City and Parramatta suburbs.

A summary of the existing train services and their associated frequencies during peak periods are provided in Table 2.2.

Table 2.2: Summary of Existing Train Services and Frequencies

Rail Line	Route	AM Peak 7am-9am (no. of services)	PM Peak 4pm-6pm (no. of services)
T2 Inner West & Leppington	City Circle via Town Centre	16	8
	Paramatta	7	8
	Ashfield Only	1	-
	Leppington via Granville	-	6
T3 Bankstown	Liverpool via Regents Park	1	-

2.3.2 Light Rail

Light rail services operate from Marion Light Rail Station which is located 200m north of the site (approximately five-minute walk or one-minute bike ride). The L1 Dulwich Hill route provides connection between Dulwich Hill and Central via Rozelle Bay, Lilyfield, Leichhardt North, Marion and several other Inner West stations. Services are provided every 10-15 minutes between 6:00am and 11:00pm, Sunday to Thursday and until midnight on Friday and Saturday. Bicycles are permitted on the light rail where space is available.

A map of the L1 Dulwich Hill light rail route is shown in Figure 2.3.

Figure 2.3: L1 Dulwich Hill Light Rail Route

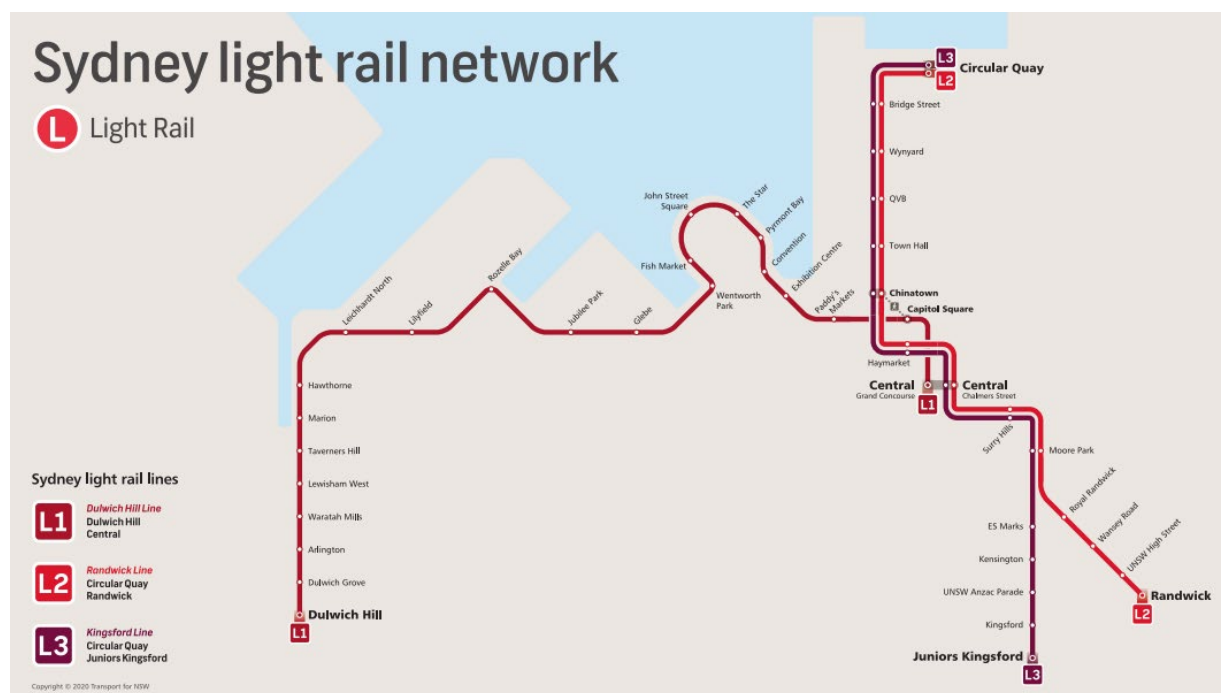

Source: Transport for NSW (accessed on 25/05/22)

In addition to this, the Taverners Hill light rail stop is located approximately 650m south of the site and also services the L1 Dulwich Hill line.

2.3.3 Bus Services

A number of bus stops are located within a 400m catchment radius of the site on Marion Street and Parramatta Road, which provide good public transport access to a myriad of destinations across Sydney every 10-30 minutes.

The existing bus service map surrounding the site is illustrated in Figure 2.4.

Figure 2.4: Existing Bus Network Map



Basemap Source: Transit Systems, Inner West and Southern region network map

2.4 Pedestrian and Cyclist Facilities

Well-established pedestrian and cycle facilities are provided within the vicinity of the site.

Sealed pedestrian paths are provided on both sides of Lords Road which provides convenient pedestrian access to properties along Lords Road and retail shops on Flood Street, including the Market Place Leichhardt shopping mall at the corner of Lords Road and Flood Street.

In the immediate vicinity of the site, signalised pedestrian crossings are provided on all legs at the Lords Road-Foster Street-Tebbutt Street intersection to provide a safe, dedicated crossing point. In addition to this, formalised pedestrian (zebra) crossings are provided across Lords Road and Flood Street, to provide pedestrians with priority near the Market Place Leichhardt shopping mall, as shown in Figure 2.5.

Figure 2.5: Existing Pedestrian (Zebra) Crossings



Source: Google Maps Australia (Street View – dated Apr 2021)

Further to this, a well-established cycle network surrounds the site, with a number of on-road and off-road bicycle routes provided near the immediate vicinity of the site. These existing cycle routes provide good cycle connectivity to surrounding suburbs, including Marrickville/Newtown suburbs, which would take about 20 to 30 minutes from the site via bike.

The existing bicycle route map surrounding the site is presented in Figure 2.6.

Figure 2.6: Existing Bicycle Route Map

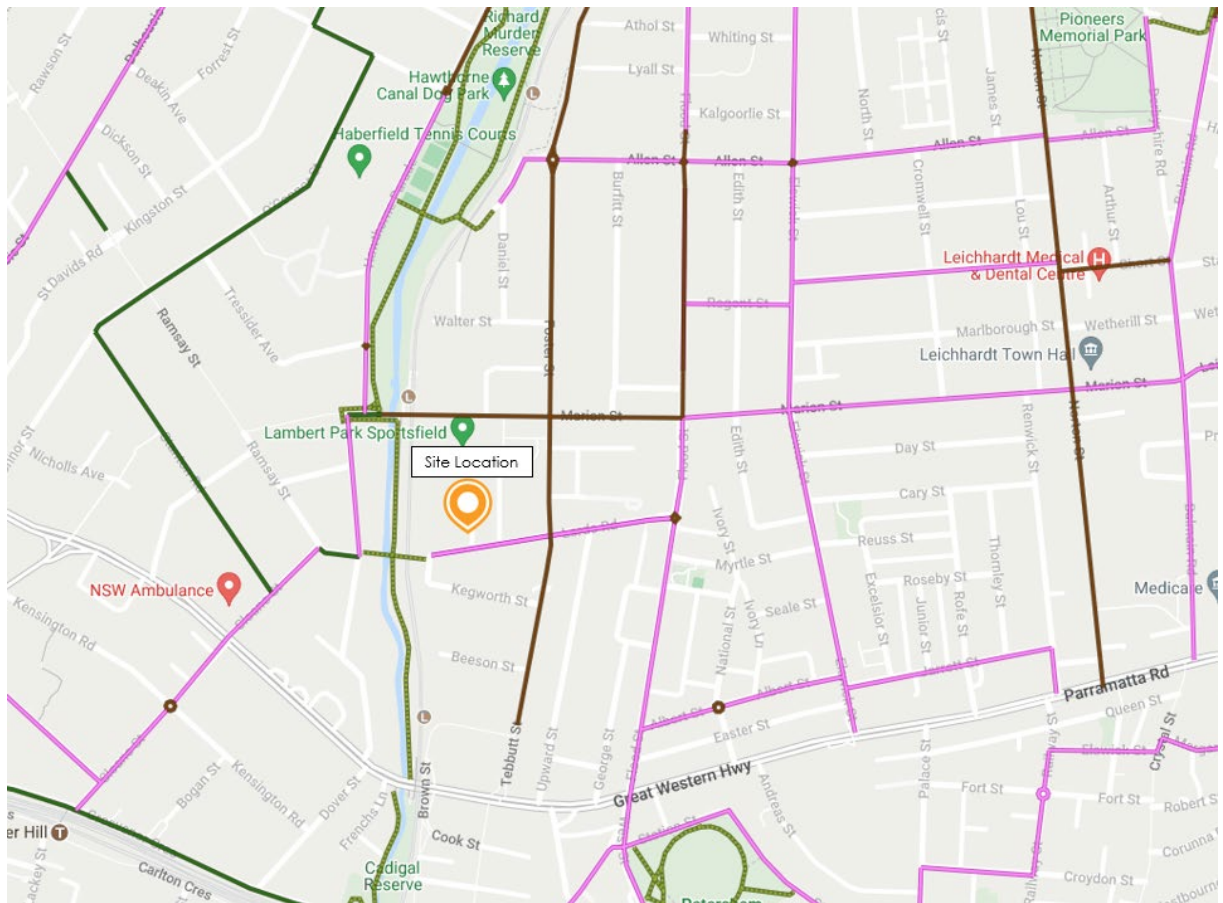

Source: TfNSW Cycleway Finder (accessed on 25/05/22)

2.5 Traffic volumes

Traffic surveys were conducted at the following key nominated intersections on 16 June 2018 and 20 June 2018:

- Foster Street-Marion Street (signalised intersection)
- Foster Street-Lords Road-Tebbutt Street (signalised intersection), and
- Tebbutt Street-Kegworth Street (priority intersection).

The nominated key intersections are outlined in red in Figure 2.8.

Figure 2.7: Existing Peak Hour Traffic Volumes

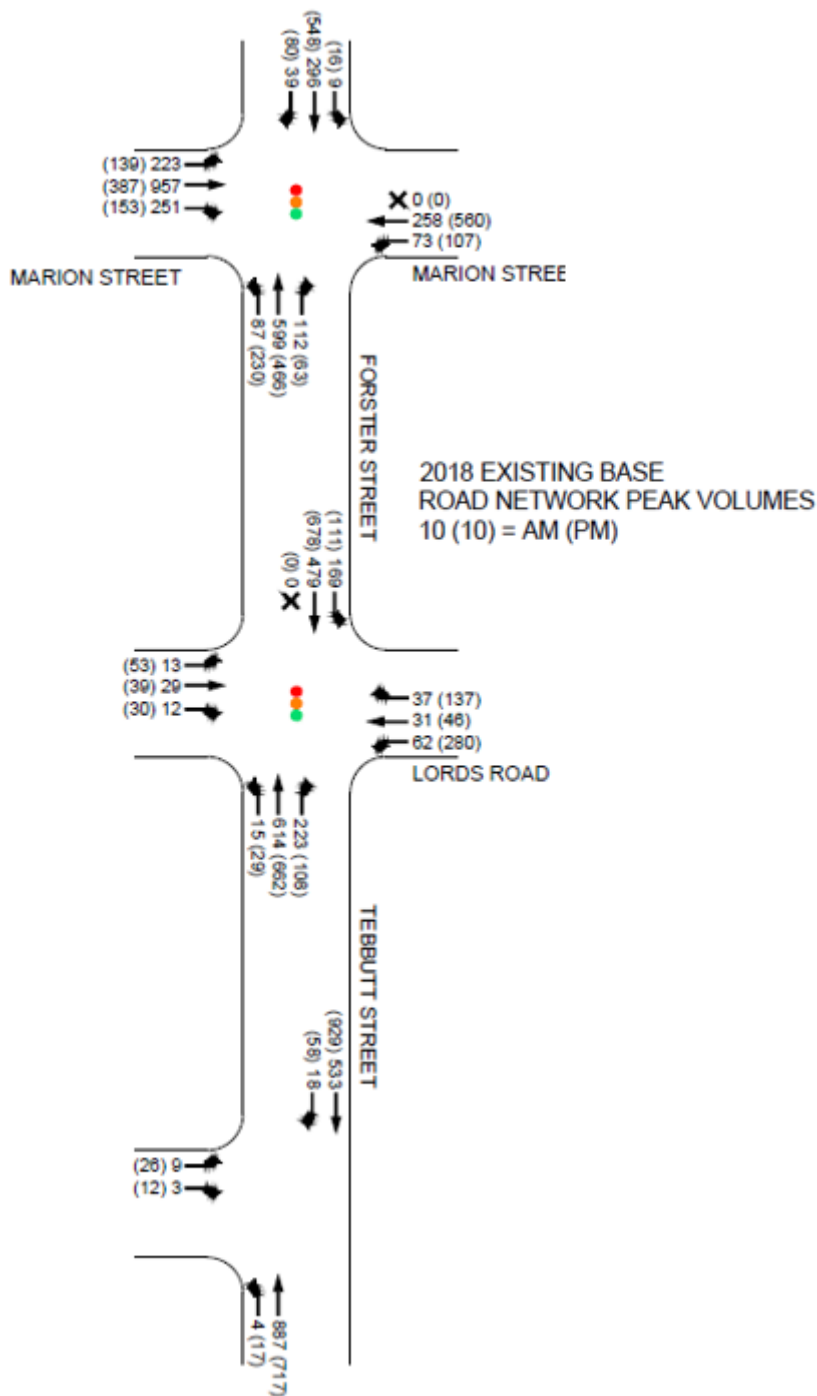
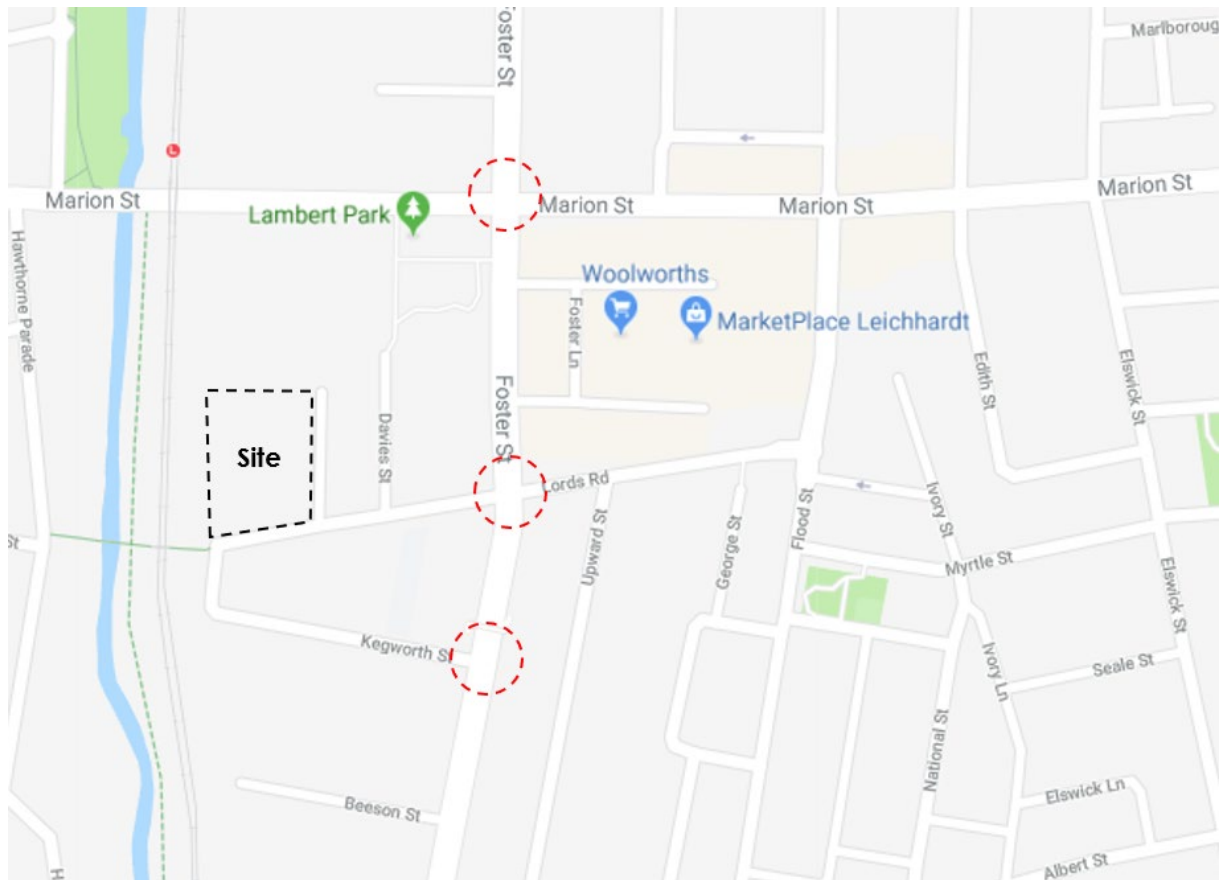

Figure 2.8: Key Nominated Intersections



The peak hour traffic volumes at the key nominated intersections are shown in Figure 2.7.

2.6 Strategic Context

2.6.1 Parramatta Road Corridor Precinct-Wide Traffic and Transport Study

The subject site falls within the Taverners Hill Precinct of the Parramatta Road Corridor Urban Transport Strategy (PRCUTS). In the context of Sydney's continued projected growth, the corridor was identified by the NSW Government in 2013 as a strategic urban renewal corridor with the capacity to support increased housing, economic activity and social infrastructure.

As part of the planning of the precinct, Inner West Council and DPIE has commissioned a transport study to analyse the transport network implications of proposals contained in the PRCUTS. The study, known as *Parramatta Road Corridor Precinct-Wide Traffic and Transport Study*, was undertaken by Cardno in 2021.

With respect to the site, the study had the following key findings:

- Lords Road functions as a key east-west cycling corridor in the precinct, providing a dedicated cycling lane and connection to the Greenway underpass.

- Transport network modelling of key intersections indicates that,
 - the nearest studied intersection to the site (Lords Road and Tebbutt Street) operates well under current conditions, with a level of service A to B.
 - However, Marion Street and Tebbutt Street, to the north of the site, is nearing capacity, and the intersection of Parramatta Road and Tebbutt Street is at capacity.
 - By 2036 (without the development of the precinct), the Tebbutt Street/ Lords Road intersection is expected to operate at a LoS E, due to spillback from the Parramatta Road and Tebbutt Street intersection.
 - To accommodate the PRCUT precinct planning, several localised intersection upgrades are proposed along Parramatta Road and other key links. Upgrades include the intersection of Parramatta Road/ West Street/ Flood Street, near the site, with the removal of parking/kerbside lane in northbound direction to provide space for dedicated right turn lane in southbound direction.
 - Following the upgrades, the queue spillback from Parramatta Road would be greatly reduced and the intersection of Tebbutt Street and Lords Road is expected to operate with a LoS B in the year 2036.
 - The proposed upgrades have not yet been endorsed by Transport for New South Wales. Further detailed studies may be required.

2.6.2 Inner West Traffic and Transport Needs Study

In 2021, Traffix prepared the *Traffic and Transport Needs Study (TTNS)* for Inner West Council. The purpose of the study was to consolidate the planning controls, including the Development Contributions Plan, of the former councils that have amalgamated to form Inner West Council (i.e. Marrickville, Ashfield and Leichhardt).

The report reviews the existing and future transport needs of the Inner West LGA and identified key requirements and improvements over a 10-year time frame.

The key outcomes identified, as it relates to the subject DA site and adjoining areas include:

- Prioritised walking link in accordance with PRCUTS guidelines (generous footpaths, seating, landscaping and priority over other modes at intersections) - Lords Road between light rail line and Flood Street
- Prioritised walking link in accordance with PRCUTS guidelines (generous footpaths, seating, landscaping and priority over other modes at intersections) - Tebbutt Street between Parramatta Road and Lords Road
- Prioritised walking link in accordance with PRCUTS guidelines (generous footpaths, seating, landscaping and priority over other modes at intersections) – Flood Street between Parramatta Road and Lords Road

- Mid-block raised pedestrian crossing in Lords Road for pedestrian desire line through Lambert Park.
- Raised pedestrian crossing at Lords Rd and Kegworth St to access Greenway.

3 Proposed Development

3.1 Proposal Description

The proposed development involves the construction of a mixed-use development at 67-75 Lords Road, Leichhardt. As noted previously, this planning proposal seeks approval to rezone the site from IN2 Light Industrial to R3 Medium Density Residential to permit a mixed-use development.

The development is expected to include a total of 220 residential apartments, of which, 160 would be affordable housing units and 60 would be independent seniors living units. In addition, a minimum of 2,000m² of non-residential floor area is proposed.

An indicative masterplan has been prepared by Platino Properties for traffic analysis purposes, with the following mix:

- 220 residential apartment units
 - 7% x studio units (15 units)
 - 28% x 1-bedroom units (62 units)
 - 30% x 2-bedroom units (66 units)
 - 35% x 3-bedroom + units (77 units).
- 2,297m² GFA Non-Residential

Appropriate basement car parking would be provided within the site to facilitate the residential and non-residential uses. An assessment of the car parking requirements for the proposed development is provided in Section 4.

In addition to this, as part of the proposed development, there will be opportunities to create a shared space environment within the site, complemented by communal open space, to encourage a vibrant, cohesive environment and social interaction, as well as sustainable transport modes such as walking and cycling.

3.2 Vehicle Access and Circulation

The site is to have two vehicular access points, including:

- a two-way driveway into a basement car park and
- a two-way shared roadway.

The shared road would enable pick-up/ drop-off activities to be undertaken on-site, by vehicles no larger than a B99 car.

The ramp into the basement would accommodate vehicles up to a 12.5m HRV, with the loading dock located in within the basement.

The proposed access arrangements are shown in Figure 3.1 with full architectural plans provided in Appendix A.

Figure 3.1: Vehicle Access on Ground Level

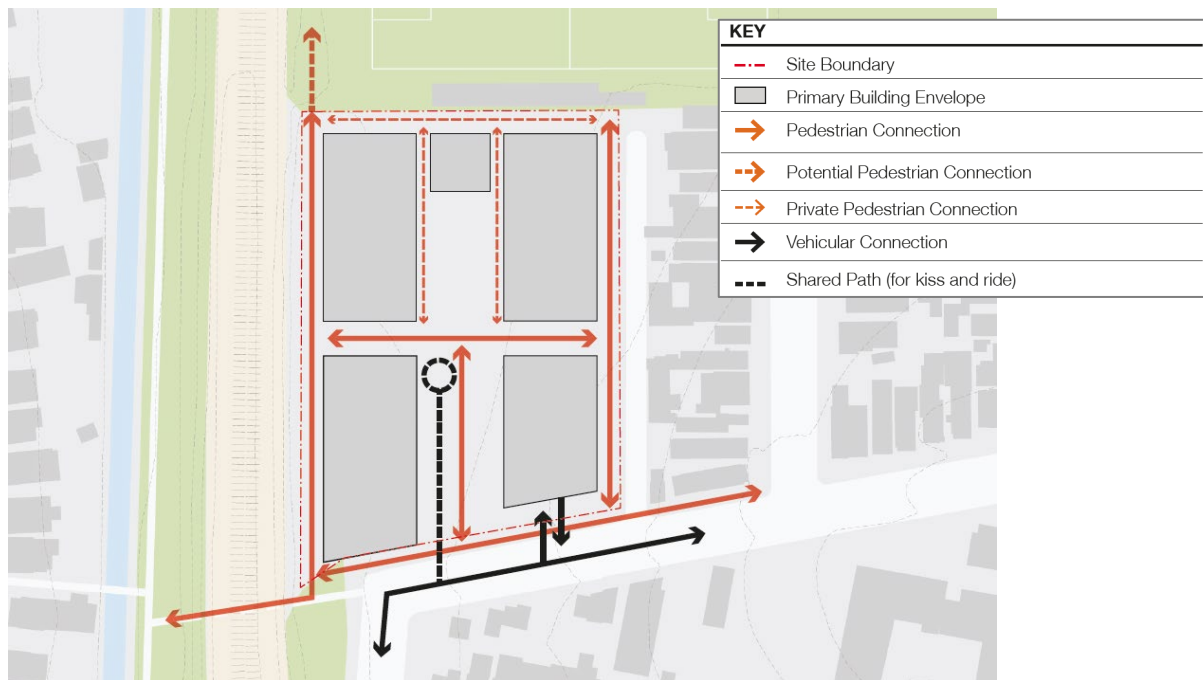

Source: SJB Architects

3.3 Pedestrian Connectivity

As part of the development of the site, it is proposed to improve pedestrian connectivity through the site, for those living and working on-site and also the general public.

Notably, the western boundary of the site, is to accommodate a public through-site link that would connect to the crown land adjoining Lambert Park Sportsfield (to the north) and the Hawthorn Pedestrian Tunnel (to the south), which provides access to the Greenway Shared Path.

There is no existing connection to the land adjoining Lambert Park Sportsfield, however, the creation of a public through-site link would offer the opportunity to provide a connection and thereby, provide a shorter walking path to Marion Street and Marion Light Rail Station.

The pedestrian links through the site is shown in Figure 3.1.

4 Parking Assessment

4.1 Car Parking Requirement

The car parking requirements for the proposed development has been assessed with reference to the following three documents:

- Leichhardt Development Control Plan (DCP) 2013
- Transport for New South Wales (TfNSW) Guide to Traffic Generating Developments 2002, and
- Parramatta Road Corridor Urban Transformation Strategy (PRCUTS) 2016.

The car parking assessment for the proposed development is detailed below.

4.1.1 Leichardt DCP 2013

The car parking requirement for various development land uses is set out in Council's DCP. The DCP for the Inner West Local Government Area is yet to be published. Prior to council amalgamations in 2016, the proposed site was located in the Leichhardt Local Government Area. As such, the parking requirements for the site have been assessed against the Leichhardt DCP 2013.

The car parking requirements are set out within *Part C1.11 – Parking* in the DCP. The DCP does not provide specific parking requirements for independent seniors living units. As such, the requirements for general residential is sourced.

For the purposes of this assessment, the non-residential component is assumed to be primarily commercial floor area. A summary of the car parking requirements arising from the proposal is summarised in Table 4.1.

Table 4.1: Leichhardt DCP 2013 Car Parking Requirements

Land use	Size	DCP Parking Rates	DCP Parking Requirement	
Residential	Studio	15	0 to 0.5 spaces per dwelling	0-8 spaces
	1-bed	62	0.333 to 0.5 spaces per dwelling	21-31 spaces
	2-bed	66	0.5 to 1 space per dwelling	33-66 spaces
	3-bed+	77	1 to 1.2 spaces per dwelling	77-93 spaces
	Visitors		0.09 to 0.125 spaces per dwelling	20-28 spaces
	<i>Sub-Total</i>	220	-	151-226 spaces
Commercial/ community use	-	2,297	Min: 1 space per 100m ² of GFA; Max: 1 space per 80m ² of GFA	23-29 spaces
Total			174-255 spaces	

Table 4.1 indicates that the proposed development would require 174-255 car spaces to service the proposed uses, including 151-226 residential spaces and 23-29 commercial spaces.

Further to this, car share spaces would also need to be considered and provided in accordance with Council's DCP requirements. That is, a minimum of one car share space is to be provided for any residential development containing more than 50 residential units and a minimum of one car share space per 50 car spaces provided for the commercial land use.

4.1.2 PRCUTS

The site falls within the Taverners Hill Precinct boundary as set out in the PRCUTS document. A summary of the car parking rates as set out in the PRCUTS for the proposed development is provided in Table 4.2 as maximum parking rates.

Table 4.2: PRCUTS Development Parking Requirements

Land use		Size (units/m ²)	Maximum PRCUTS Parking Rate	PRCUTS Parking Requirement
Residential	Studio	16	0 spaces per dwelling	0
	1-bed	62	0.3 space per dwelling	19
	2-bed	66	0.7 space per dwelling	47
	3-bed or more	79	1 space per dwelling	77
	Visitors	223	0 space per dwellings	0
	<i>Sub-Total</i>	223		143
Commercial		2,297	1 space per 150m ²	16
Total				159

Table 4.2 indicates that the proposed development would require a maximum of 159 car parking spaces using the above PRCUTS car parking rates.

4.1.3 Housing SEPP

160 of the 220 dwellings is to be affordable housing. Affordable housing falls under the requirements of the *State Environmental Planning Policy (Housing) 2021* (Housing SEPP).

Based on the Housing SEPP, a consent authority may not refuse an in-fill affordable housing development, if the following minimum parking requirements are met:

- at least 0.5 parking spaces are provided for each dwelling containing 1 bedroom,
- at least 1 parking space is provided for each dwelling containing 2 bedrooms and
- at least 1.5 parking spaces are provided for each dwelling containing 3 or more bedrooms.

Based on the above rates, and the bedroom split described in Section 3.1, the independent living units cannot be refused if a provision of 161 spaces is provided.

The rates in the Housing SEPP are notably higher than the DCP's and the PRCUT's maximum rates. As such, it is not proposed to adopt the rates from the Housing SEPP.

4.1.4 TfNSW Traffic Generation Studies

As noted above, the DCP does not provide specific parking rates for seniors living units, as such, the parking rates for 'housing for aged persons' was referenced from the TfNSW Guide to Traffic Generating Developments 2002. The parking rates are as follows:

- housing for aged persons (resident funded developments – self-contained units)
 - 2 spaces per 3 units
 - 1 space per 5-units (visitor parking)

Using the above metrics, the proposed 60 independent living units would require some 53 car parking spaces, with the following car parking breakdown:

- 41 residential spaces
- 12 residential visitor spaces, and

Comparatively, the 60 units would be required 41-61 car spaces based on the DCP rates. TfNSW's car parking requirement for seniors living is within the parking requirement range of the DCP.

4.1.5 Summary of Car Parking Assessment

Based on the above car parking assessment and parking codes/guidelines, a car parking provision of 159 (as per PRCUT) to 255 (as per the DCP) spaces would be appropriate to serve the proposed development. At this stage, it is envisaged that some 205 car parking spaces could be accommodated within a basement car park, with access off Lords Road.

This car parking provision is considered satisfactory to serve the proposed development based on the above car parking assessment. Further to this, appropriate allocation for car share facilities, bicycle and motorcycle parking spaces would be provided in accordance with relevant parking codes/guidelines.

The car park and associated elements are proposed to be designed in accordance with the design requirements set out in the relevant Australian Standards for car parking facilities.

4.2 Bicycle Parking Requirement

The DCP states that bicycle parking should be provided as per the following rates:

- Seniors housing
 - 1 space per 10 staff
 - 1 per 20 self-contained dwelling units,
 - 1 space per 30 dwellings for visitors
- Commercial:
 - 1 space per 10 staff
 - 1 space per 400m² for visitors.

It is proposed to comply with the DCP requirement.

4.3 Motorcycle Parking Requirement

The DCP states that motorcycle parking should be provided at the rate of one space for developments that require 1 to 10 vehicle spaces and 5% of the required vehicle parking thereafter.

It is proposed to comply with the DCP requirement.

4.4 Loading Requirement

The DCP states that loading areas are to be provided as per the rates provided within the TfNSW Guide to Traffic Generating Developments 2002. Based on the TfNSW Guide, the development should be provided with five loading and servicing spaces, with 50% being suitable for trucks.

Table 4.3: TfNSW Servicing and Loading Recommendations

Land use	Size	Rate	Requirement
Residential	220	4 + 1 space per 100 units over 200 (50% of spaces adequate for trucks)	4 spaces
Commercial	2,297	1 space per 4,000m ² (50% of spaces adequate for trucks)	1 space
Total			5 spaces

Based on experience of other commercial and residential sites, it is expected that at least one truck loading bay would be required for regular waste collection vehicles and the occasional removalist vehicle. Outside of these services, residential and commercial land uses do not have much need for large truck deliveries.

Remaining servicing requirements relate to general servicing and maintenance vehicles e.g. plumbers, electricians, landscaper etc, which require no larger than a van or ute.

Additionally, commercial and residential may share truck facilities, which the TfNSW rates do not take into consideration.

As such, it is proposed to provide one loading dock, sufficient to accommodate a 12.5m Heavy Rigid Vehicle (HRV) and four courier spaces for service vehicles.

4.5 Parking Layout Design Requirements

The car park layout will be designed in line with the requirements of the Australian Standard for Off Street Car Parking (AS/NZS2890.1:2004 and AS/NZS2890.6:2009) and Off Street Commercial Vehicle Facilities (AS/NZS2890.2:2018) in terms of:

- Bay and aisle widths
- Adjacent structures
- Turnaround facilities
- Circulation roads and ramps
- Ramp grades
- Height clearances
- Internal queuing
- Pick-up/ set-down area
- Parking for persons with disabilities
- Motorcycle parking
- Ambulance parking, if any.

5 Traffic Generation

5.1 Existing Site Traffic Generation

5.1.1 Traffic generation based on RMS Rates

As indicated in Section 2.1, the existing site is occupied by a number of industrial/warehouse, recreational and commercial tenancies, including a gymnasium, with a combined floor space of 10,000m².

Based on the existing land uses of the site, the traffic generation potential of the site has been estimated using the Roads and Maritime suggested traffic generation rates, as shown in Table 5.1.

Table 5.1: Traffic Generation of Existing Land Uses

Use	Area (m ²)	Trip Generation Rate	Trip Generation Potential
Gym	1,234	9 trips per 100m ²	111 trips
Office/ Community Space	1,392	1.6 trips per 100m ²	23 trips
Light Industrial	5,744	1 trip per 100m ²	58 trips
Warehouse	1,609	0.5 trips per 100m ²	8 trips
Total	9,979	-	200 trips

Table 5.1 indicates that the existing site could generate up to 200 trips during peak periods based on the existing tenancies and use of the site, if all tenancies were operating at maximum occupancy.

5.1.2 Traffic Generation Based on Survey Data

Traffic surveys have been undertaken to determine the site's actual traffic generation under existing conditions.

Surveys were carried out in 2013 as part of Varga's traffic and parking assessment report dated 15 May 2014 to support the initial planning proposal rezoning application for the site. Based on these surveys, the site (which was not fully occupied at the time of the surveys) generated up to 105 trips during peak periods, as shown in Figure 5.1, Figure 5.2, Figure 5.3 and Figure 5.4. However, the site was not fully occupied at the time of the surveys and as such, had the potential to generate a higher level of traffic.

More recently, TTPP commissioned traffic surveys at the existing site access points to record the existing traffic generation of the site between 20 August and 19 August 2018. Based on these traffic surveys, 30 trips (AM Network Peak) 67 trips (AM Site peak) and 110 trips (PM Peak) were recorded to/from the site. This is generally consistent with the traffic generation

surveys carried out in 2013 by Varga, though it is understood that all tenancies were occupied in 2018.

This indicates that the occupation of additional tenancies did not relate to an increase in traffic generation between the years 2013 and 2018. This is as a result of the activities of some of the tenancies being less intense than permitted under the approved land uses. For example, several tenancies were operating as recreational classes (e.g. art, kung fu and pottery as summarised in Table 2.1) which would generate substantial lower traffic than the approved use as an office.

On this basis, it is considered that the traffic generation of the site could reach up to 200 trips per hour, if the tenancies were used at the intensity likely to be generated by the approved uses (as per above RMS rates).

A summary of the existing 2018 traffic generation of the site is provided in Figure 5.5. It is notable that the peak hour traffic movements at the busiest time of day currently do not coincide with the school drop off and pick up times.

Figure 5.1: Western Site Access Count (AM)



R.O.A.R. DATA
Reliable, Original & Authentic Results
Ph.88196847, Fax 88196849, Mob.0418-239019

Client : Varga Traffic Planning
Job No/Name : 4867 LEICHHARDT Lords Rd Counts
Day/Date : Thursday / 31st October 2013

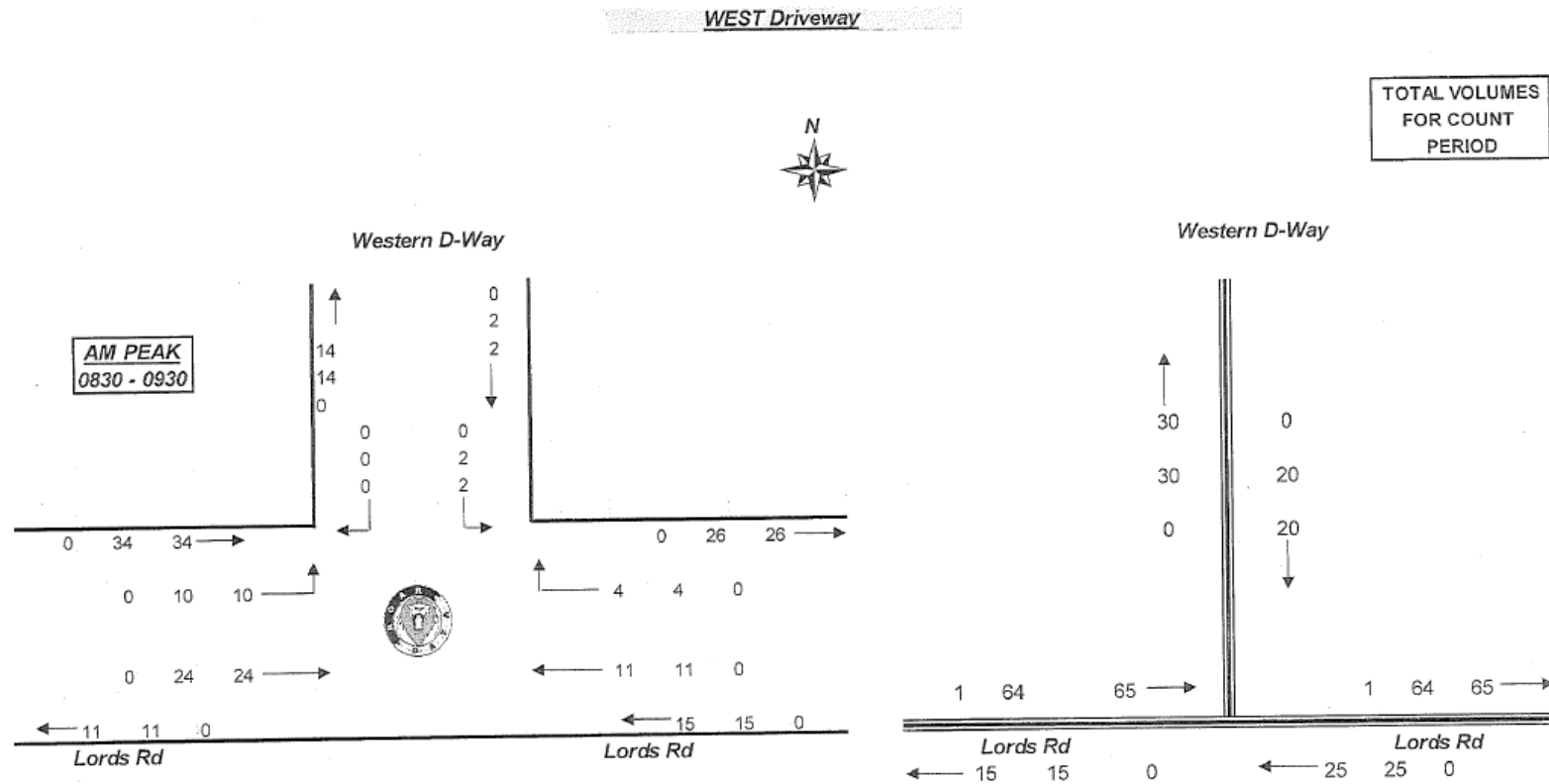

Figure 5.2: Western Site Access Count (PM)



R.O.A.R. DATA

Reliable, Original & Authentic Results
Ph.88196847, Fax 88196849, Mob.0418-239019

Client : Varga Traffic Planning
Job No/Name : 4867 LEICHHARDT Lords Rd Counts
Day/Date : Thursday / 31st October 2013

WESTERN Driveway



TOTAL VOLUMES
FOR COUNT
PERIOD

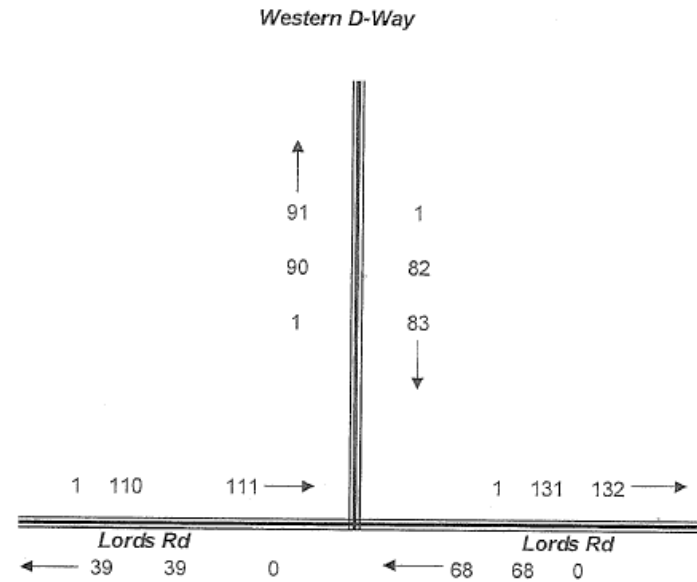
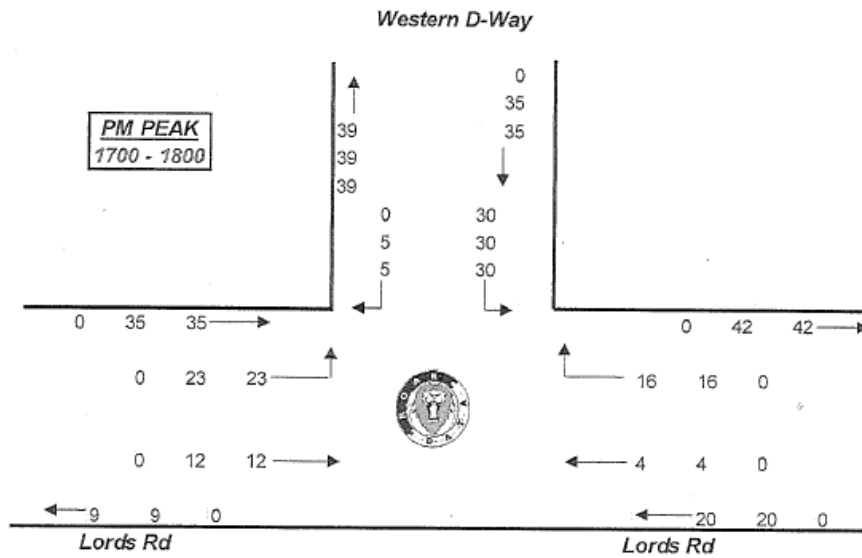

Figure 5.3: Eastern Site Access Count (AM)



R.O.A.R. DATA
Reliable, Original & Authentic Results
Ph.88196847, Fax 88196849, Mob.0418-239019

Client : Varga Traffic Planning
Job No/Name : 4867 LEICHHARDT Lords Rd Counts
Day/Date : Thursday / 31st October 2013

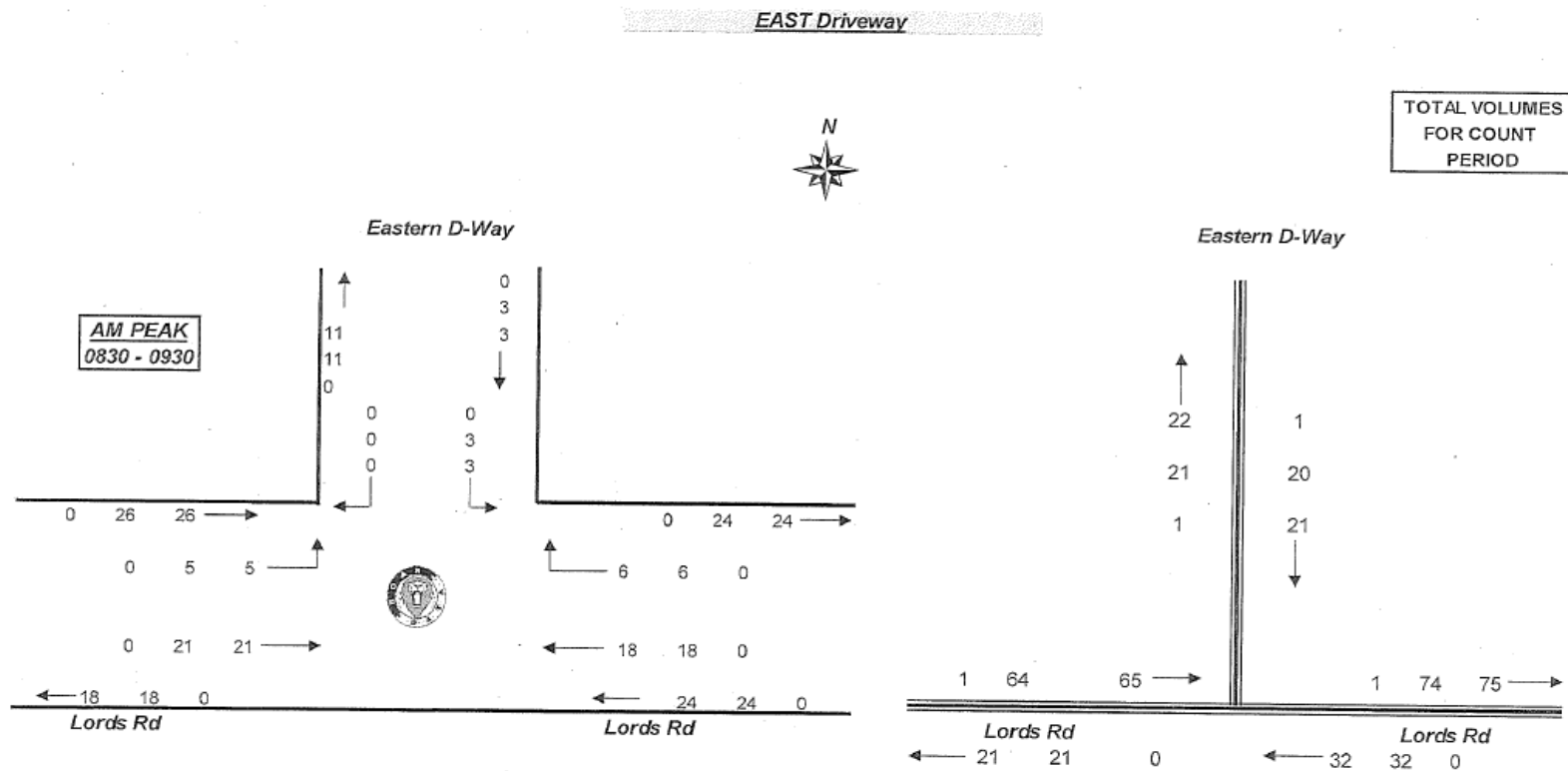

Figure 5.4: Eastern Site Access Count (PM)



R.O.A.R. DATA

Reliable, Original & Authentic Results
Ph.88196847, Fax 88196849, Mob.0418-239019

Client : Varga Traffic Planning
Job No/Name : 4867 LEICHHARDT Lords Rd Counts
Day/Date : Thursday / 31st October 2013

EASTERN Driveway



TOTAL VOLUMES
FOR COUNT
PERIOD

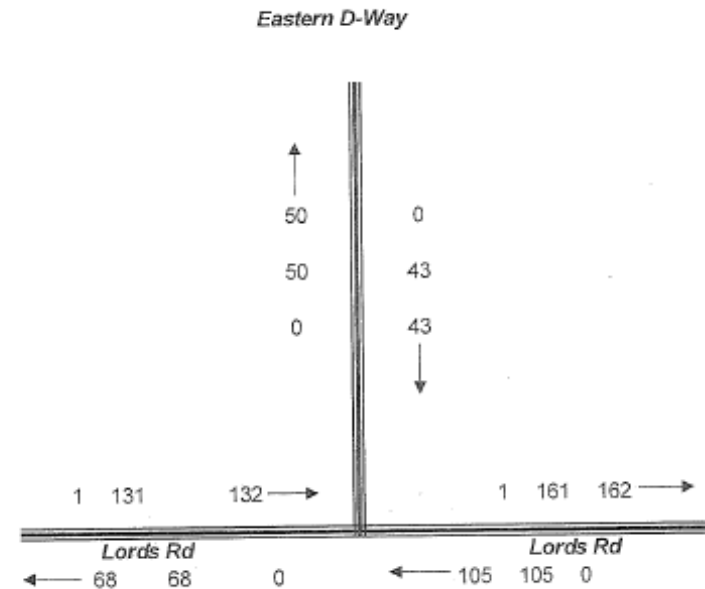
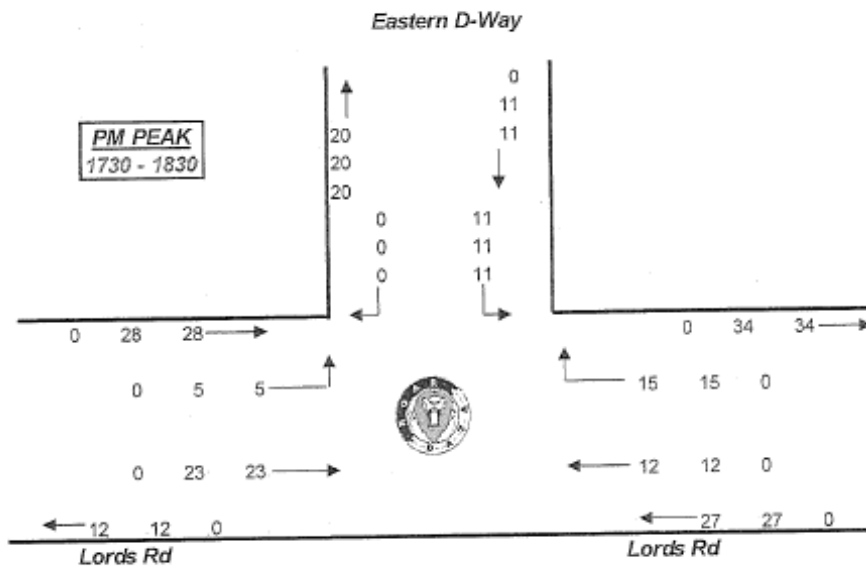
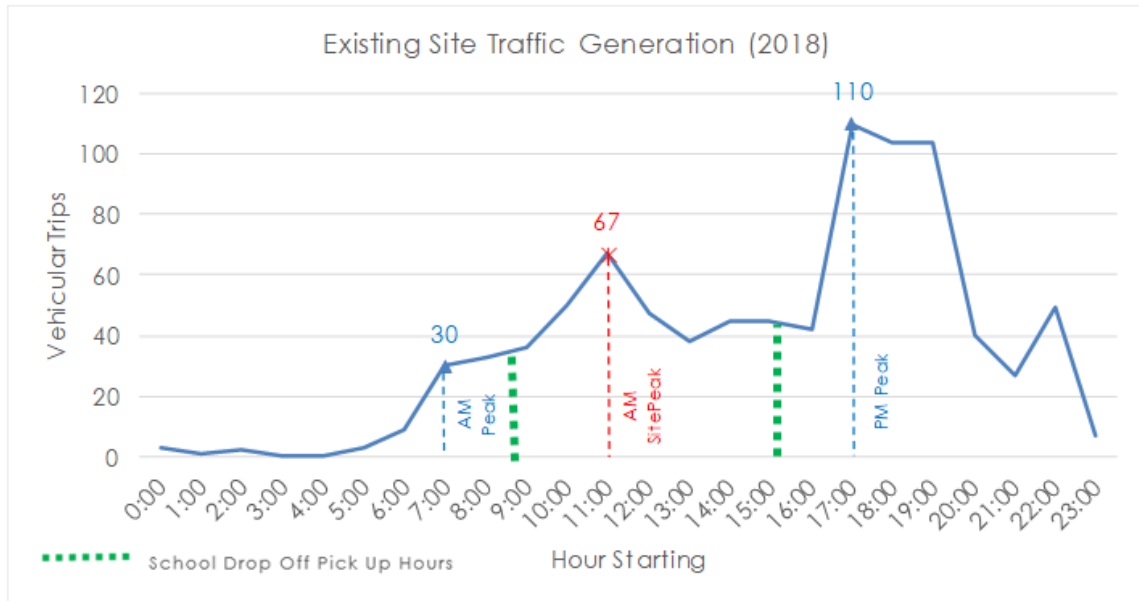

Figure 5.5: 2018 Existing Site Traffic Generation Profile



5.2 Proposed Development Site Traffic Generation

The indicative masterplan for the proposed development is as follows:

- 220 residential units
- 2,297m² non-residential.

The *Guide to Traffic Generating Developments TDT 2013/04a* provides vehicle trip rates for five seniors living sites in the Sydney Metropolitan area in Appendix C2. The average trip rate of these five sites of 0.18 trips per unit has been adopted in the PM peak. It is noted in the Guide that the morning site peak hour does not generally coincide with the network peak hour. However, conservatively, the PM peak trip rate of 0.18 trips per unit has also been adopted for the AM peak.

For the purposes of this assessment, the non-residential land use is assumed to be commercial floor area, which has a trip rate of 1.6 trips per 100m² in the AM peak and 1.2 trips per 100m² in the PM peak.

Using the above metric, the proposed development could be expected to generate 76 and 67 trips during the AM and PM Peak respectively.

Based on the most recent survey data (2018), the proposed development is expected to result in a net increase of 46 trips (which is a combination of in and out movements) in the AM Peak and net reduction of 42 trips in the PM Peak, as shown in Table 5.2. An increase of 46 vehicles per hour is a minor increase of traffic and relates to one additional vehicle every one to two minutes.

The addition of 46 vehicle movements per hour distributed through the road network would show no discernible difference in a traffic modelling software.

Table 5.2: Net Proposed Development Traffic Estimates

Scenario	AM Peak (7am-8am)	PM Peak (5pm-6pm)
2018 Existing Site Traffic Generation	30 vph	110 vph
Proposed Development Traffic	76 vph	67 vph
Net Development Traffic	46 vph	-41 vph

N.B. The AM and PM Peaks have been assessed against the road network peak times based on 2018 traffic surveys. The site's existing AM peak occurs outside of the network peak hours.

Notwithstanding, the existing site could generate up to 200 trips during the peak periods based on the approved land uses. As noted in Section 5.1.2, some of the tenancies were operated at a lower intensity than permitted under the approved land use.

Therefore, it is pertinent to note that the proposed development is actually expected to result in a net reduction of trips compared to the existing / approved use when fully occupied and as such, this traffic assessment is considered conservative.

Further to this, it is expected that the proposed development would result in less heavy vehicle movements compared to the existing scenario, which is currently occupied by light industrial/commercial tenancies. As such, from a traffic perspective, the proposed development could not be expected to result in any adverse traffic implications onto the surrounding road network, compared to the existing use and traffic generation potential of the site.

5.3 Summary of Traffic Analysis

Based on the above analysis, the proposed development on its own, would have a negligible impact on the road network generating only around one vehicle movement per minute in the peak hours.

Compared with the historic traffic generation of the site, there would be only a minor increase in traffic in the morning and a minor reduction in traffic in the afternoon. Traditional traffic modelling software would register no significant difference in its results with the addition of 46 traffic movements.

A comparison of 2013 and 2018 survey data against RMS traffic generation rates, indicates that the existing site has the potential to generate up to 200 vph, with several former tenants undertaking activities that are less intense than permitted under the approval. Furthermore, the approved land uses generate a high proportion of heavy vehicle traffic compared to the proposed land uses. As such, the proposed development with a total of 67-76 vehicle trips, has a significantly lower traffic generating potential than the approved site.

The cumulative redevelopment of the entire precinct, as discussed in Section 2.6, would have an impact on the surrounding road network. Notably, the Tebbutt Street and Lords Road intersection is expected to operate at a LoS E by the year 2036, due to spillback from the Parramatta Road and Tebbutt Street intersection.

However, the *Parramatta Road Corridor Precinct-Wide Traffic and Transport Study*, recommends several upgrades along the Parramatta corridor which would have a domino effect of improving conditions at Tebbutt Street. These upgrades have not yet been endorsed by TfNSW and it is understood that further precinct wide analysis may be undertaken by government.

6 Green Travel Plan

6.1 Overview

The key role of a Green Travel Plan (GTP) is to bring about better transport arrangements to manage travel demands, particularly promoting more sustainable modes of travel, modes which have a low environmental impact such as walking, cycling, public transport and better management of car use.

As part of a GTP, a number of policies and procedures would be put in place at a site to encourage transport choice to and within the site, namely public transport, walking and cycling. These measures would effectively assist in managing the use of private vehicle trips and parking within the area to reduce congestion and cumulative impacts of vehicle emissions upon air quality.

This section provides a framework for the implementation of such a travel plan.

6.2 Transport Plan Framework

The transport sector is a large contributor of Australia's energy-related greenhouse gas emissions through fossil fuels such as petrol, oil, diesel and gas. Whilst transport is a necessary part of life, the effects could be managed through the implementation of a travel plan.

A GTP is a package of coordinated strategies and measures to promote and encourage sustainable travel, such as walking, cycling and public transport etc. Such plans aim to influence the way people move to/from a business, residential complex or any other organisation to deliver better environmental outcomes and a range of travel choices, whilst also reducing the reliance on private car usage, particularly single occupancy car trips.

The planning of the new development would need to accommodate innovative ideas to better manage the transport demand of the project. It would be necessary to introduce new measures to ensure that trips generated by the proposed development are not solely private car based, particularly single occupancy trips.

6.3 Types of Travel Plans

There are two distinct types of travel plan, these being:

1. To change the travel behaviour at an existing site (i.e. reduction of car use, especially if only used by one person). Such plans would be implemented at large administrative buildings (e.g. hospital or government buildings). This would aim to achieve a modal shift when compared against a stated benchmark. This would

include monitoring the plan over a period after opening with more measures introduced if stated objectives were not achieved.

2. To influence the travel behaviour of a site prior to it being occupied. This can include such measures as locating the site next to a railway or light rail station, reducing on-site parking (especially for commercial buildings). Providing information and ensuring the development ties in with the sustainable active travel initiatives outside of the site. This travel plan would aim to achieve a lower car driver mode upon occupation compared with comparable sites. Whilst monitoring and management post occupation might be appropriate if the development is an office building, if it is a residential building there is little scope for a developer to influence travel behaviour post occupation.

The subject site therefore falls into the latter category where the majority of green travel initiatives are provided prior to occupation of the site.

6.4 Green Travel Plan Initiatives

A green travel plan is proposed to be implemented as part of any development approval for the site, with green travel plan initiatives intended to be provided prior to the occupation of the site. These green travel plan initiatives would promote the use of more sustainable modes of travel (i.e. walking, cycling, car share and public transport) and subsequently, reduce vehicle trips to/from the area. Such measures would include (but not limited to):

- Appointment of a Travel Plan Co-ordinator to ensure the ongoing monitoring and evaluation of the plan.
- provision of reduced car parking within the site to limit availability of car parking spaces to reduce car ownership
- creation of high quality pedestrian/shared environments and cycling facilities to encourage cycling and walking
- provide car sharing facilities and promote the availability of such car sharing pods to reduce private car ownership
- provide free opal cards to all residents upon occupation with pre-loaded credit so that travel patterns can be influenced from Day 1
- provision of public transport noticeboards to notify all residents/occupants of the alternate transport options available and a transport access guide for all new occupants
- provision of high quality telecommunication points to reduce the need for travel off-site
- a half yearly newsletter for every resident after occupation to outline the latest news on sustainable travel initiatives in the area.

In fact, such green travel plan initiatives (e.g. provided residents/occupants pre-loaded Opal cards from Day 1 and a welcome pack with public transport information) have been put in

place in other similar developments, including Mirvac's Harold Park development, which has resulted in car traffic generation rates being some 50% lower than predicted in the original traffic impact assessment. This is further discussed in Section 6.5.

This site is considered comparable with the Harold Park site due to its proximity to high frequency public transport facilities. The site is located approximately 200m south from the Marion light rail stop, whilst the Harold Park site is located about 400m south from the Jubilee Park light rail stop. Both light rail stops (Marion and Jubilee) services the L1 Dulwich Hill line.

Following the occupation of the Harold Park site with the green travel initiatives in place, the peak hour traffic generation per unit was recorded as being 0.1-0.12 trips per unit based on surveys conducted 3-month post occupation in 2015 and recent surveys conducted this year (2018).

Thus, it is envisaged that the implementation of a green travel plan could reduce trips generated by the development, particularly to target residents and staff within the proposed development site.

6.5 Case Study – Harold Park Green Travel Plan

In 2011, Ken Hollyoak, whilst at Halcrow, was commissioned by Mirvac to complete the transport assessment for the Harold Park Masterplan comprising 1,250 residential apartments, 7,300m² of retail floor area and 3,850m² of commercial floor area.

As part of the proposed Harold Park Masterplan, a Green Travel Plan was prepared to encourage and promote the future use of transport by residents in a sustainable and environmentally friendly manner. In fact, the following Green Travel Plan initiatives were implemented as part of the proposed development:

- compliance with the stringent parking controls applicable to the site
- creation of street networks and associated cycleways, footpaths and links to encourage cycling and walking
- provision of a Transport Access Guide (TAG) given to every new occupant of the dwelling
- public transport noticeboards within the development to notify all residents and visitors of the alternate transport options available
- provision of free yearly GoOccasional, car share membership for the initial occupation of dwellings to allow two drivers registered per membership
- provision of free weekly light rail and travel ten bus tickets for the initial occupation (N.B. this was updated to pre-loaded Opal cards for Precincts completed post-2015)
- provision of high quality telecommunication points

- provision of bicycle parking spaces for both residents and visitors in accordance with City of Sydney requirements.
- a half yearly newsletter for every household after occupation to outline the latest news on sustainable travel initiatives in the area.

The above listed measures were in place from 'Day One' to establish better transport habits at the start of occupation.

Following this, Ken Hollyoak was appointed as the Travel Plan Co-Ordinator for the Harold Park to develop, implement and monitor the effectiveness of the GTP. Surveys have since been conducted to understand the effectiveness of the Green Travel Plan initiatives.

A summary of the survey data is shown in Table 6.1.

Table 6.1: Summary of Harold Park Post-Occupation Surveys

	Initial Traffic Assessment Report Estimate (2011)	Roads and Maritime Guide TDT2013/04a	Post-Occupation Survey (2019)
Trip Rate	0.29 trips per unit	0.19 trips per unit	0.13 trips per unit

Table 6.1 indicates that the Harold Park site generates a peak traffic generation rate of 0.13 trips per unit based recent post-occupation surveys. Comparably, this is more than 50% less than what was initially envisaged for the site and 40% less than current suggested traffic generation rates in the Roads and Maritime latest technical direction for Guide to Traffic Generating Developments.

Taking the above into consideration, TTPP notes that there is strong supporting evidence to suggest the effectiveness of Green Travel Plan initiatives to reduce vehicle trips from a development site. However, that being said, it should be noted that the Harold Park site is supported by high frequency public transport facilities and located near key employment areas. On this basis, a site's proximity to public transport facilities and key employment areas/attractions is considered a critical component to assess the effectiveness of Green Travel Plan initiatives.

The subject site benefits from good public transport facilities and a range of land uses within the vicinity of the site. The proposed development complements the existing character and future vision for the area. In this regard, the implementation of green travel plan initiatives is expected to result in a similar reduced traffic generation rate compared to the Harold Park development.

7 Conclusions

This report examines the traffic and parking implications of the proposed development at 67-75 Lords Road, Leichhardt. The key findings of this report are presented below.

- The planning proposal seeks to rezone the site from IN2 Light Industrial to permit mixed-use development.
- At this stage, the proposed mixed-use development is envisaged to comprise 220 independent living units and a minimum of 2,000m² commercial/community use.
- The proposed car parking provision would be provided in accordance with the relevant parking controls/guidelines, with appropriate allocation provided for bicycle and motorcycle spaces.
- The proposal is expected to generate less traffic than the existing traffic generation potential of the site.
- The existing traffic generation potential of the site is estimated to generate up to 110 trips during peak periods. The proposal is estimated to generate 76 and 67 trips during the AM and PM Peak respectively. This results in a net increase of 46 trips in the AM Peak and a net reduction of 41 trips in the PM Peak.
- A green travel plan should be implemented as part of the proposed development to facilitate a modal shift towards public transport usage as opposed to car usage, particularly for single-occupancy car trips. This is likely to further reduce traffic generated by the proposal.

Overall, it is concluded that the traffic and parking aspects of the proposed development would be satisfactory.

Appendix A

Architectural Plans

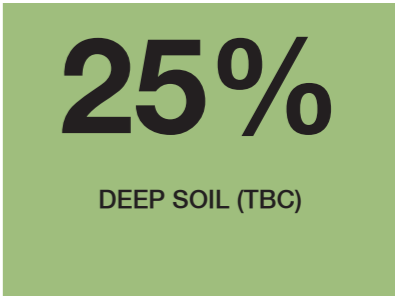
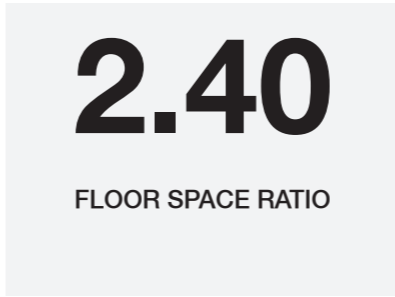

1.3 DRAFT Indicative Scheme

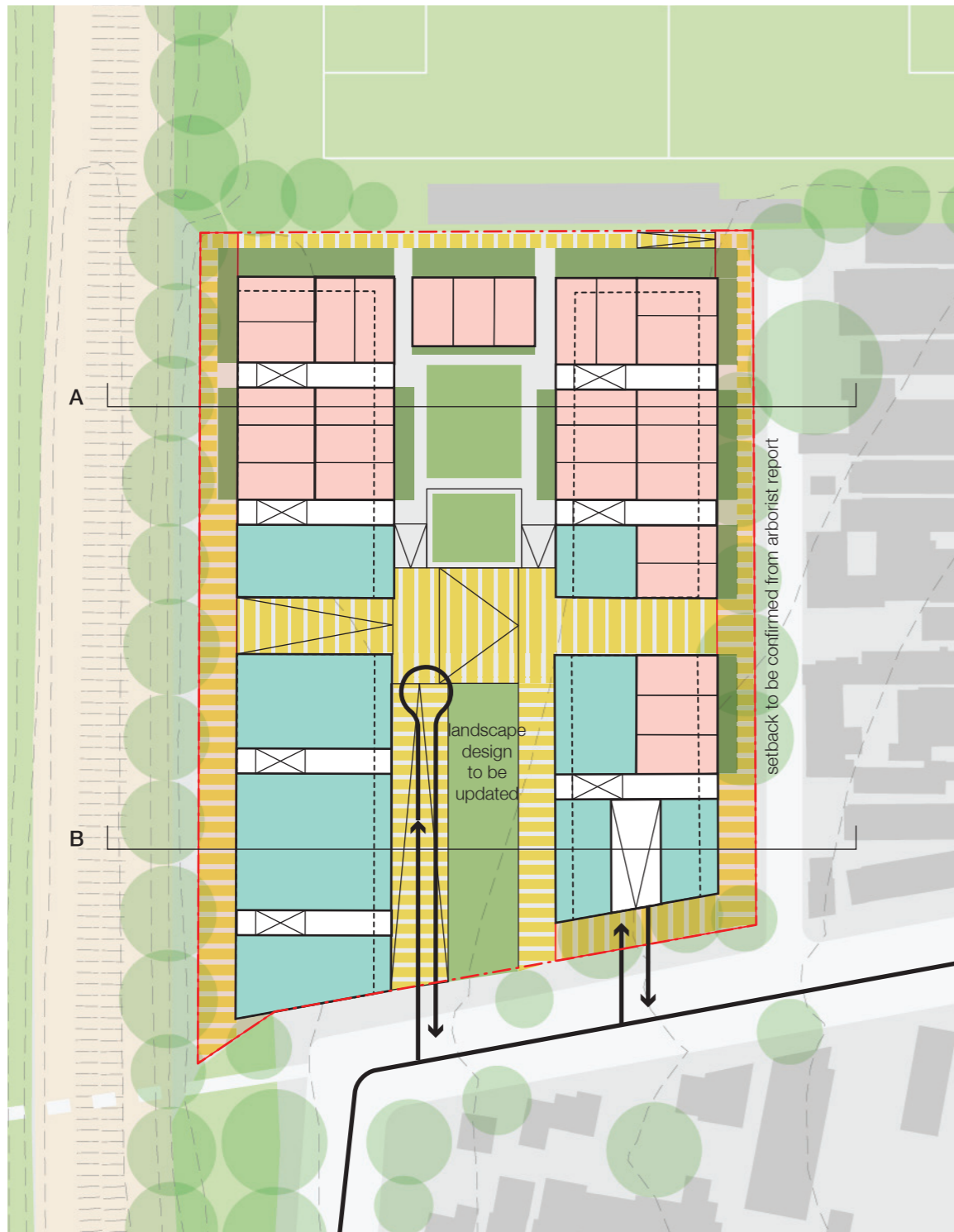

1:1000 @ A3

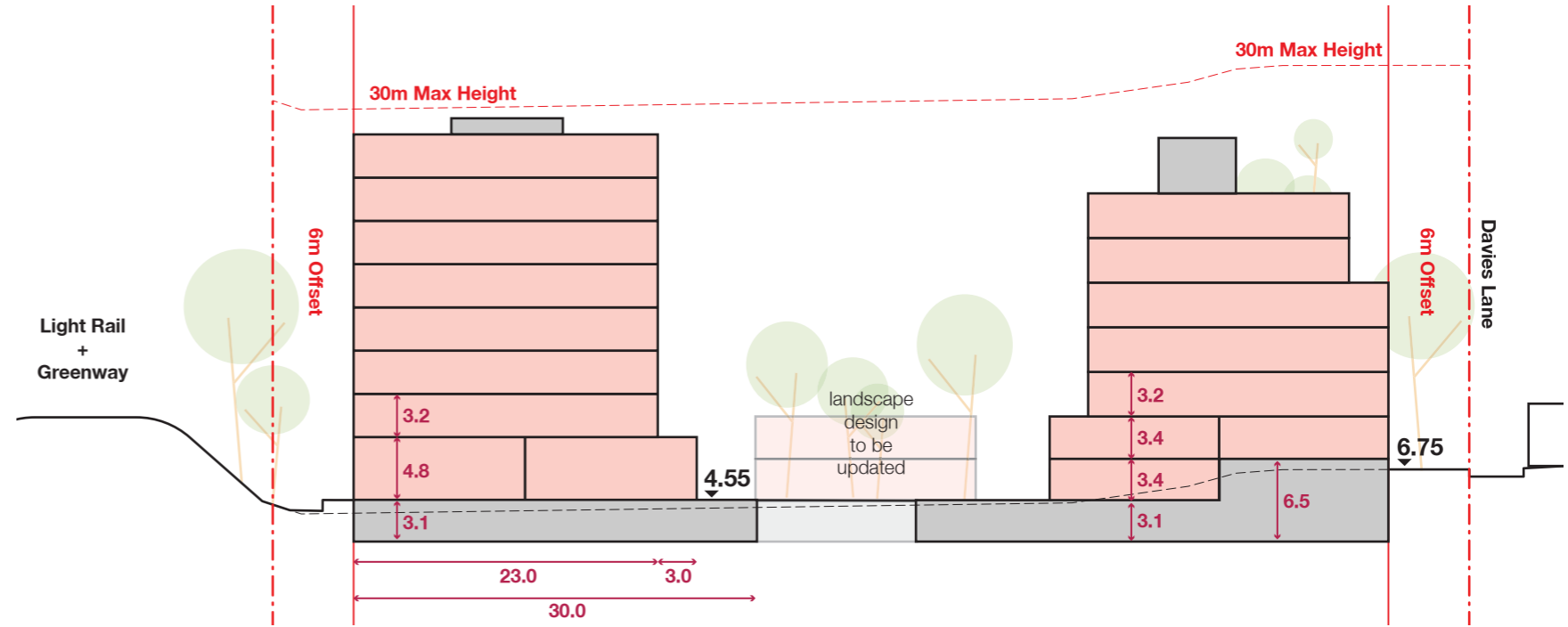

Section A

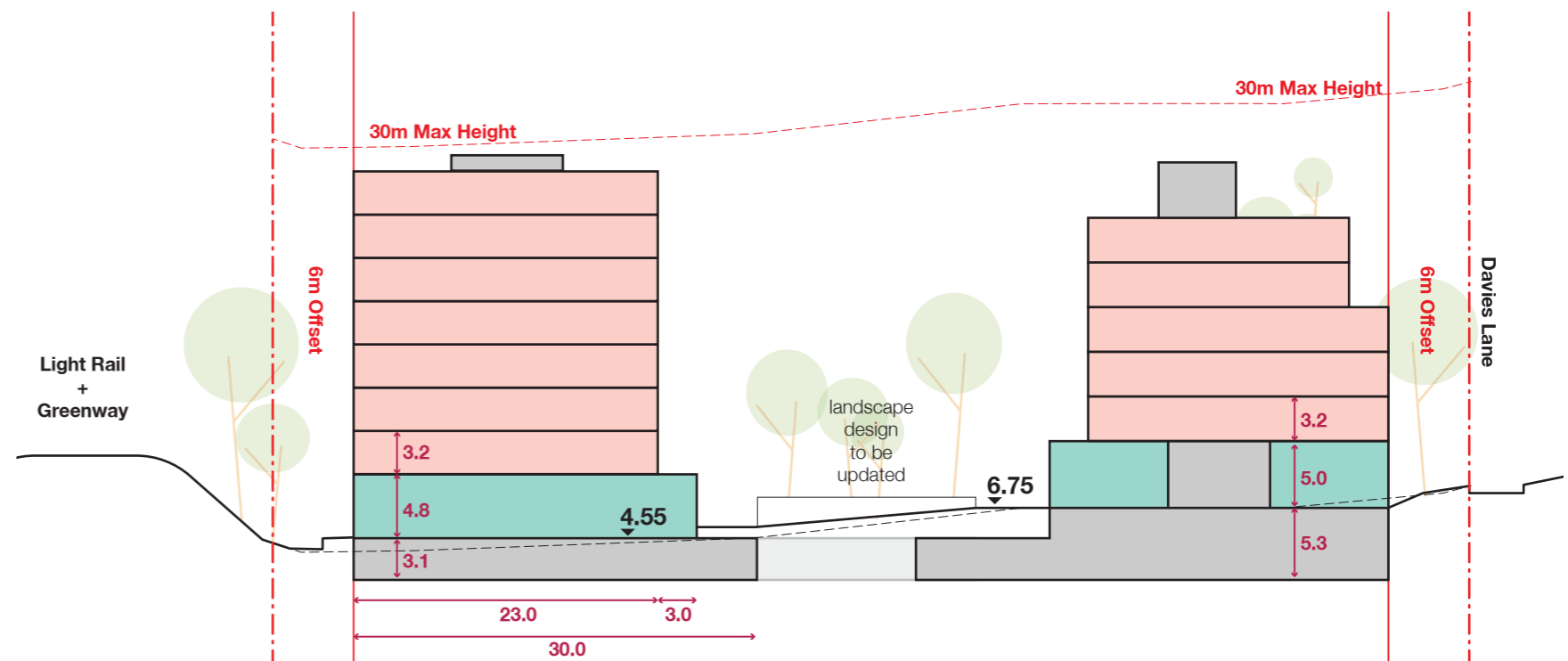

Section B

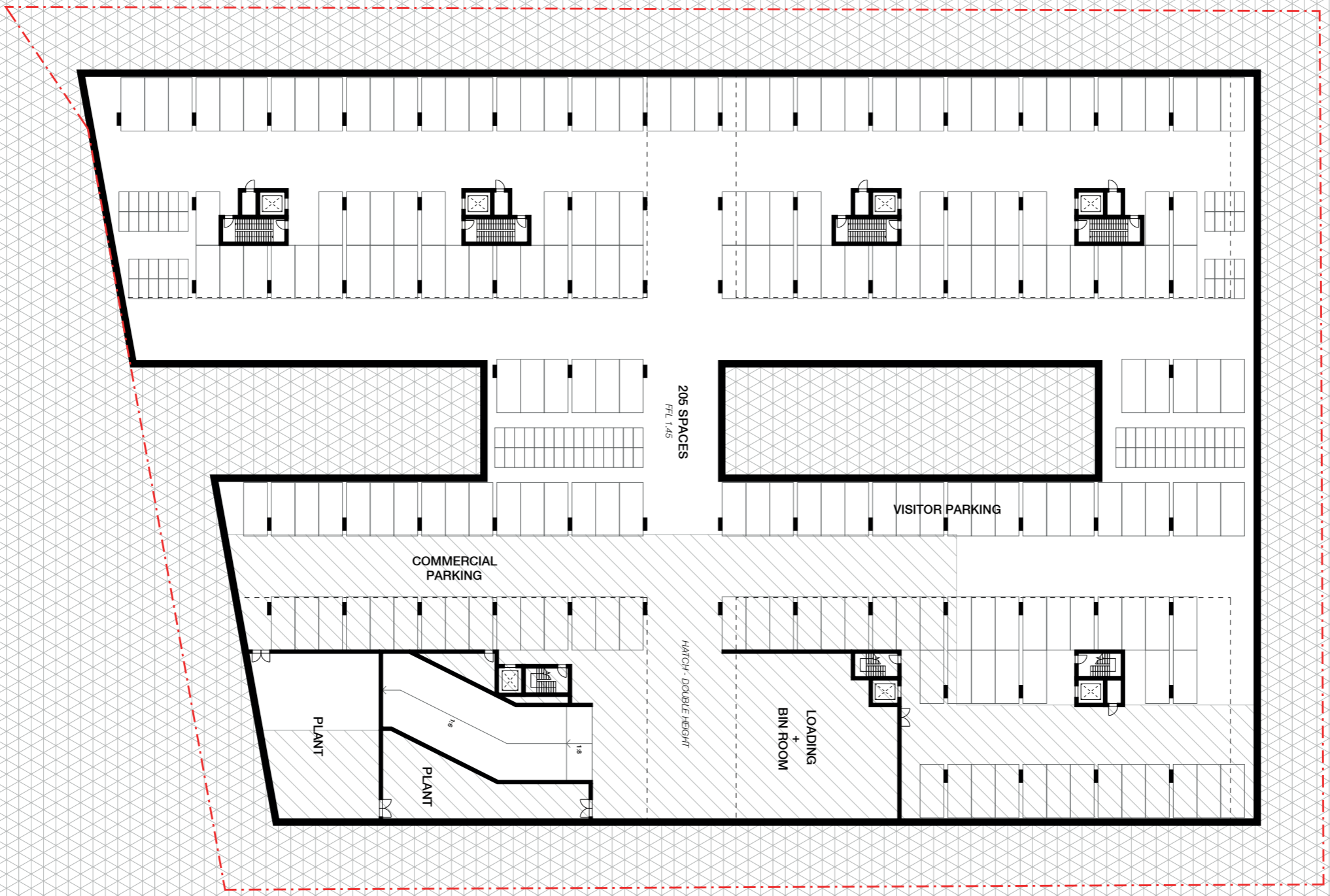

Basement Plan
 Scale 1:500 @ A3
 0 5 10 15 20 25

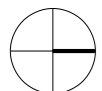

Drawing number [00]
Revision number [00]

Project number 6624
Project name Lords Road

Project address 67-75 Lords Road, Leichardt
Client Platino

SJB Architects
 Level 2, 490 Crown Street, Surry Hills NSW 2010
 T. 61 2 9390 9911 sjb.com.au
 SJB Architecture (NSW) Pty Ltd
 ABN 20 310 373 425 ACN 081 094 724
 Adam Haddow 7189 John Pradai 7004





Ground Plan (WEST)
 Scale
 1:500 @ A3

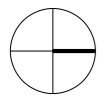
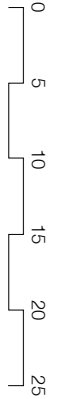

Drawing number
 [00]
Revision number
 [00]

Project number
 6624
Project name
 Lords Road

Project address
 67-75 Lords Road, Leichardt
Client
 Platino

SJB Architects
 Level 2, 490 Crown Street, Surry Hills NSW 2010
 T. 61 2 9390 9911 sjb.com.au
 SJB Architecture (NSW) Pty Ltd
 ABN 20 310 373 425 ACN 081 094 724
 Adam Haddow 7189 John Pradai 7004





Ground Plan (EAST) + Level 1 Plan (WEST)
 Scale 1:500@A3

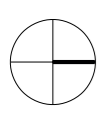
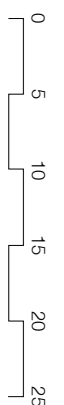

Drawing number [00]
Revision number [00]

Project number 6624
Project name Lords Road

Project address 67-75 Lords Road, Leichardt
Client Platino

SJB Architects
 Level 2, 490 Crown Street, Surry Hills NSW 2010
 T. 61 2 9390 9911 sjb.com.au
 SJB Architecture (NSW) Pty Ltd
 ABN 20 310 373 425 ACN 081 094 724
 Adam Haddow 7188 John Pradell 7004



The Transport Planning Partnership
Suite 402 Level 4, 22 Atchison Street
St Leonards NSW 2065

P.O. Box 237
St Leonards NSW 1590

02 8437 7800

info@tpp.net.au

www.tpp.net.au