

[IWC_PP_2018_02]
Planning Proposal for Residential Zoning

**1-5 Chester Street,
Annandale**

REVISED TRAFFIC AND PARKING ASSESSMENT REPORT

1 May 2019

Ref 17381

TABLE OF CONTENTS

1.	INTRODUCTION	1
2.	PLANNING PROPOSAL	5
3.	TRAFFIC ASSESSMENT	14
4.	PARKING ASSESSMENT	34

APPENDIX A TRAFFIC SURVEY DATA

LIST OF ILLUSTRATIONS

Figure 1	Location
Figure 2	Site
Figure 3	Road Hierarchy
Figure 4	Existing Traffic Controls
Figure 5	Existing Public Transport Services
Figures 6a - 6c	Existing Bicycle Routes
Figure 7	PCRUTS Improvement Strategy

1. INTRODUCTION

This revised report has been prepared to accompany an amended planning proposal to Council for a residential development to be located at 1-5 Chester Street, Annandale (Figures 1 and 2).

The original planning proposal involved the rezoning of the land from *IN2 – Light Industrial* to *R3 – Medium Density Residential*, increasing the permissible FSR from 1:1 up to 2.6:1 as well as increasing the permissible height up to 17m [Ref: IWC_PP_2018_02].

The maximum development potential of the subject site under the original planning proposal with *R3 – Medium Density* zoning yielded approximately 43 apartments in a new part-five/part-six storey apartment building.

After extensive consultation with Council, the planning proposal has been amended and now involves retaining the existing *IN2 – Light Industrial* zoning and 17m height limit whilst increasing the proposed FSR slightly up to 2.76:1, comprising 2:1 residential and 0.76:1 industrial/creative office. In order to ensure the continued provision of employment and urban function on the site, a minimum of 989m² of non-residential floor area is to be provided on the ground and first floor levels.

With respect to the proposed upper levels, two options are proposed. Option 1 comprises four levels of residential apartments with a total yield of 26 units, including 1, 2 & 3 bedroom variants. Option 2 comprises a four level “new generation” boarding house with a total of 83 rooms for student accommodation, plus communal areas.

Off-street parking is proposed to be provided in a new single-level basement car parking area located beneath the building which will ultimately be designed to comply with the relevant Australian Standards. Vehicular access to the site is to be provided via a new entry/exit driveway located at the southern end of the Chester Street site frontage.

Due to market demand and actual parking requirements of student accommodation (based on existing student accommodation facilities), Option 2 is preferred by the Applicant. In this

regard, Option 2 proposes *zero* off-street parking for the student residents given the site's proximity to a number of tertiary educational establishments and an extensive range of alternate transport options. Option 2 does however propose parking for service vehicles, courier deliveries and a manager's space as well as providing high rates of motorcycle and bicycle parking. Reducing the number of car parking spaces that are to be provided on the site and encouraging alternate forms of transport such as walking, cycling and public transport, will help ease congestion on the surrounding road network. Provision of minimal car park for Student use is further supported by letter from specialist student housing operator, UniLodge, letter attached.

The purpose of this revised report is to assess the traffic and parking implications of the amended planning proposal and to that end this report:

- describes the sites and provides details of the planning proposal
- reviews the road network in the vicinity of the site, and the traffic conditions on that road network
- estimates the traffic generation potential of the amended planning proposal, and assigns that traffic generation to the road network serving the site
- assesses the traffic implications of the planning proposal in terms of road network capacity
- reviews the geometric design features of the proposed concept car parking facilities for compliance with the relevant codes and standards
- assesses the adequacy and suitability of the quantum of off-street car parking provided on the site.

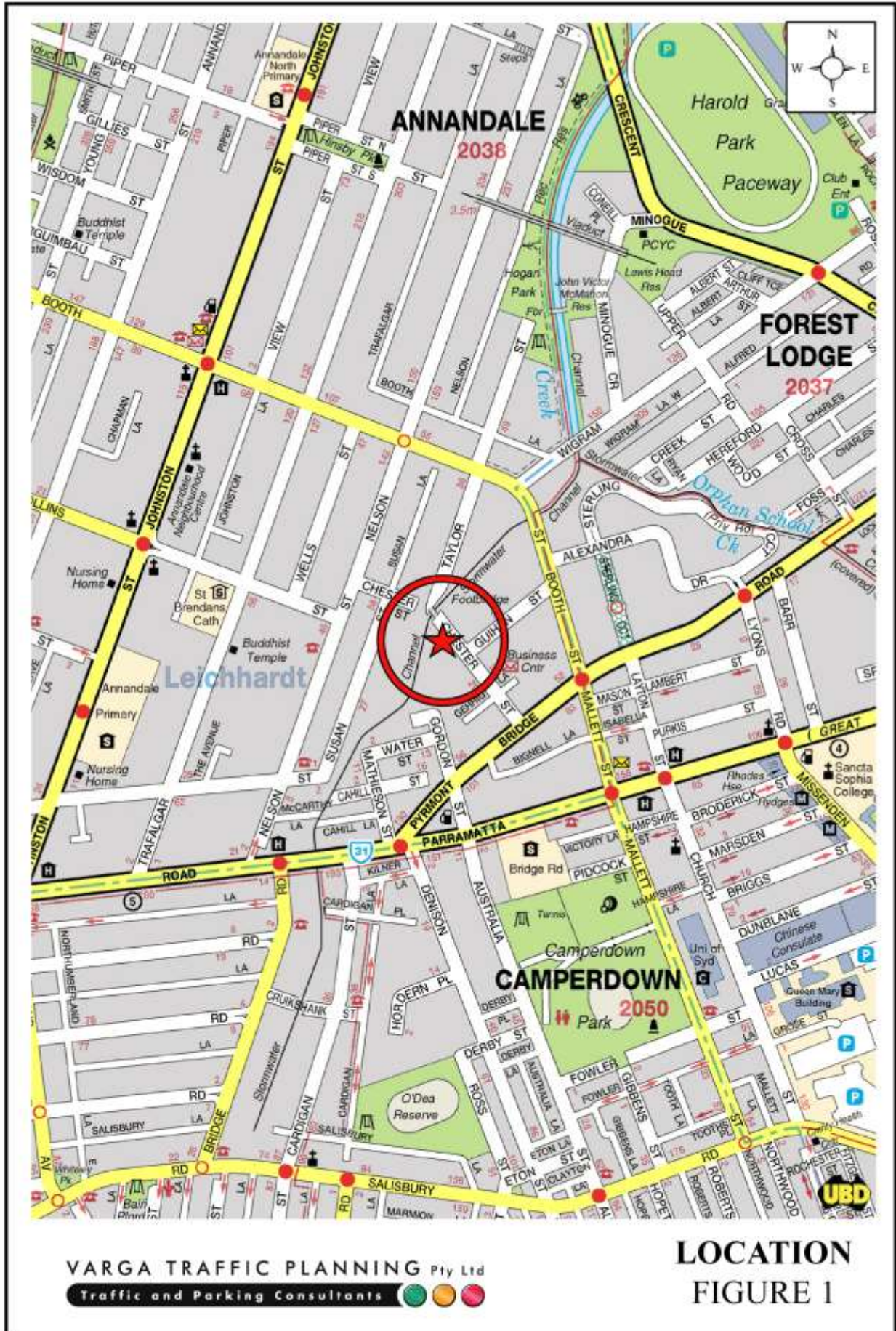

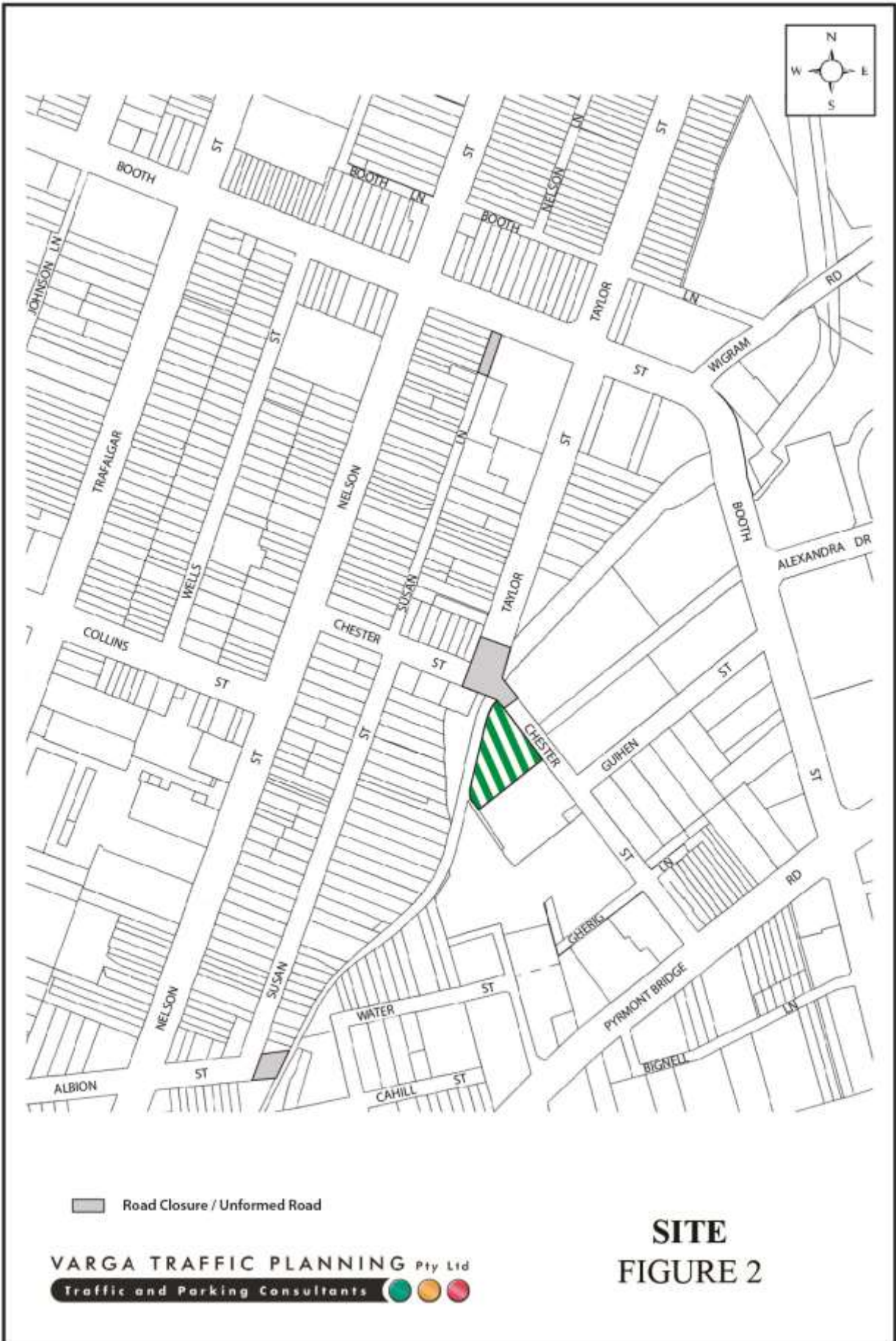

2. PLANNING PROPOSAL

Site

The subject site is located along the western side of Chester Street, at its far very northern end. The site has a street frontage of approximately 44 metres in length to Chester Street and occupies an area of approximately 1,307m².

The site is currently zoned *IN2 – Light Industrial* and is situated approximately 350m walking distance north of the *Parramatta Road Corridor* and lies within the Camperdown-Precinct as outlined in the *Parramatta Road Urban Transformation Strategy: Planning and Design Guidelines (Nov 2016)* document.

The subject site is currently occupied by an industrial building operating as a panel beating and car repair workshop.

Informal off-street parking is provided on the site, with vehicular access provided via a single driveway located at the northern end of the Chester Street site frontage. A recent aerial image of the site and its surroundings is reproduced below.

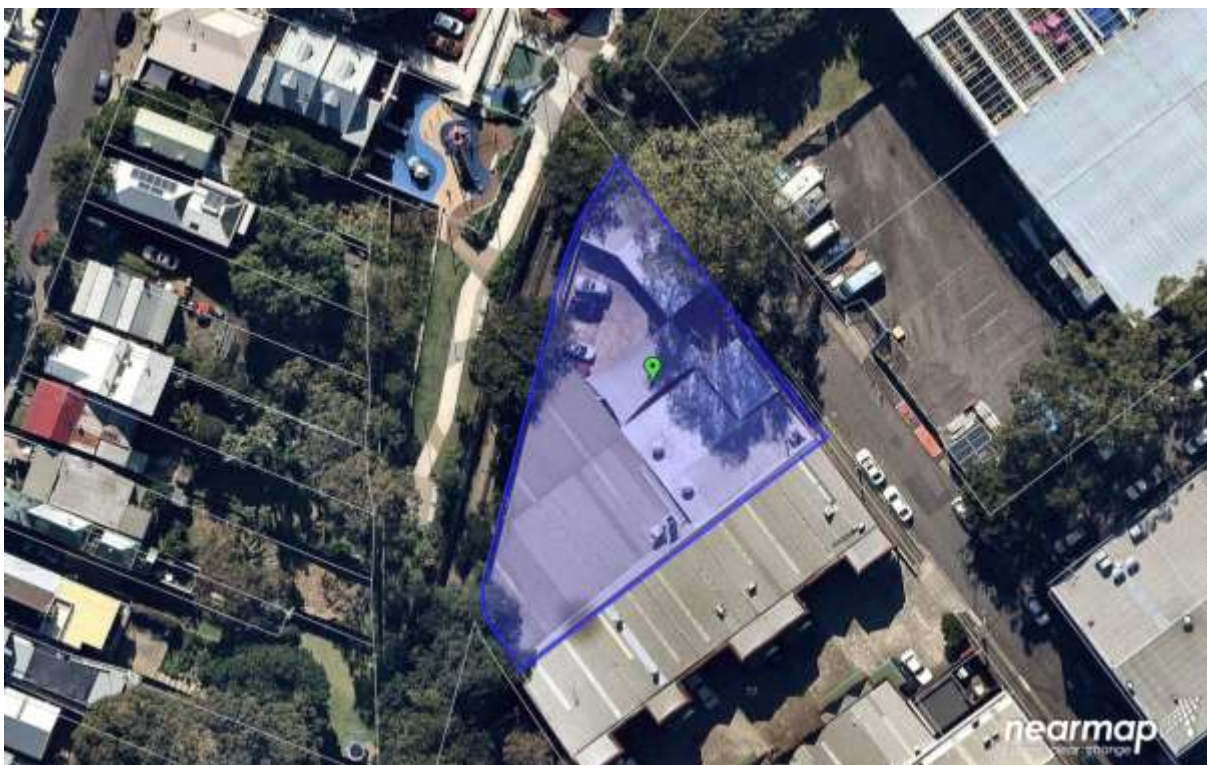

Existing Planning Controls

The current instrument that governs the mass and scale of the development on the site is contained within the *Leichhardt Local Environmental Plan (LEP) 2013*. The subject site is currently zoned *IN2 – Light Industrial* and subject to an FSR of 1:1 without height controls. It is therefore envisaged that a light industrial development comprising a cumulative floor area of 1,307m² could be achieved under the current planning controls for the site.

Amended Planning Proposal

The amended planning proposal involves retaining the existing *IN2 – Light Industrial* zoning and 17m height limit whilst increasing the proposed FSR slightly up to 2.76:1, comprising 2:1 residential and 0.76:1 industrial/creative office. In order to ensure the continued provision of employment and urban function on the site, a minimum of 989m² of non-residential floor area is to be provided on the ground and first floor levels. It is envisaged that these tenancies would be occupied by the light industrial sector ranging from the arts, technology, production and design professions, with an estimated total of 20 staff.

In addition to the non-residential component on the ground and first floor levels, the planning proposal also envisages providing residential accommodation on the four upper levels as detailed below.

Option 1 – Residential Apartments

12 x 1 bedroom apartments

10 x 2 bedroom apartments

4 x 3 bedroom apartments

Option 2 – Boarding House (Student Accommodation)

83 rooms, including an on-site manager's room, plus communal facilities

Off-street parking is to be provided for a total of 18 cars, comprising 13 commercial spaces, 1 courier space, 1 service vehicle space, 1 manager's space and 2 disabled spaces, in a new single-level basement car parking area located beneath the building which will ultimately be designed to comply with the relevant Australian Standards.

Vehicular access to the site is to be provided via a new entry/exit driveway located at the southern end of the Chester Street site frontage.

Loading/servicing for the proposed development is expected to be undertaken by a variety of light commercial vehicles such as courier vans, tradesmen's utilities and the like, which are capable of using a conventional parking space.

Concept plans of the amended planning proposal have been prepared by *AE Design Partnership Pty Ltd* and are reproduced in the following pages.

6.4 Indicative Floor Plans



Basement Level 3
(If Required)



Basement Level 2
(If Required)

Architectural drawings subject to further design resolution at DA stage



Lower Ground / Johnston's Creek Level



Basement Level 1
Parking for employment & Caretaker to boarding house.

Architectural drawings subject to further design resolution at DA stage

ac design partnership
architecture urban design planning

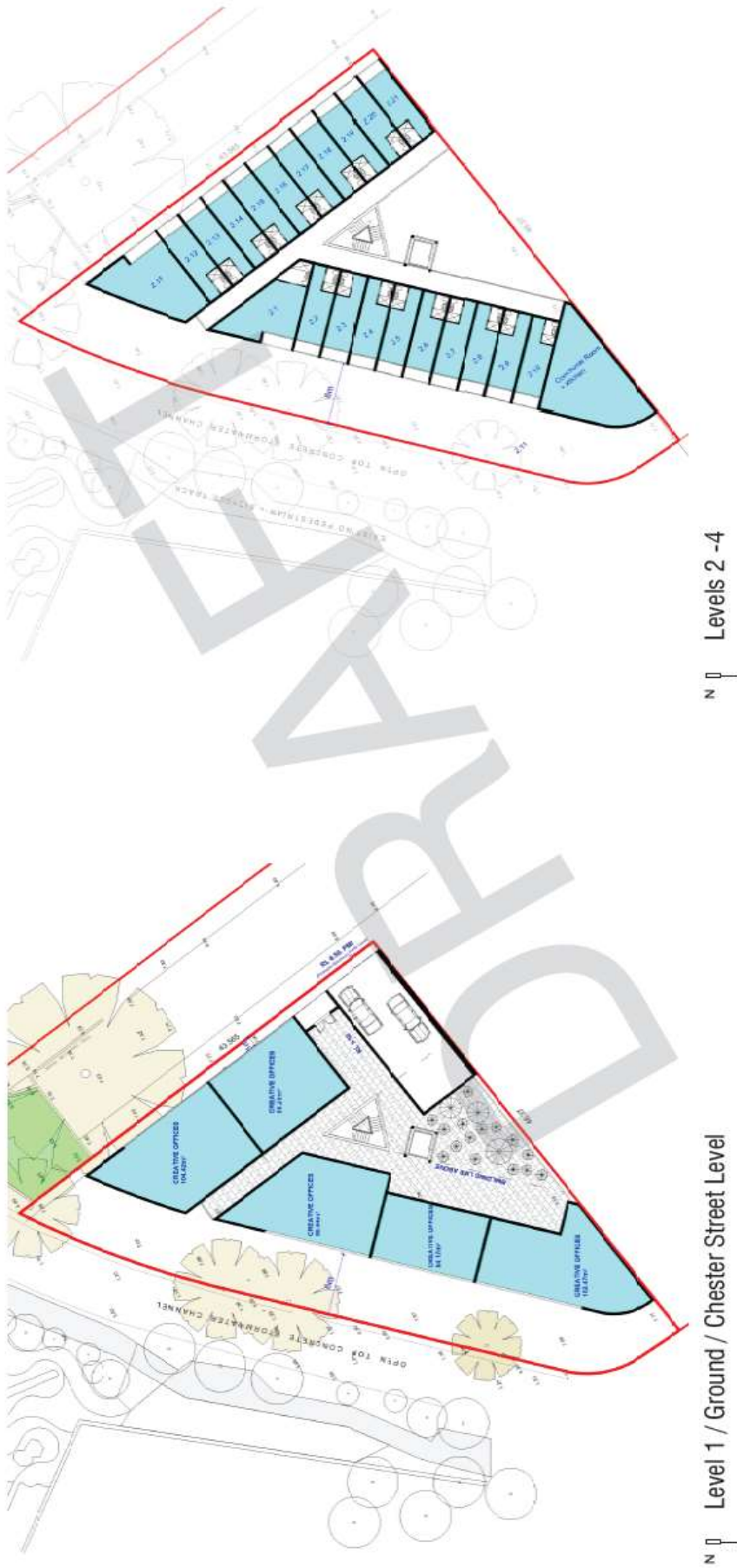

Architectural drawings subject to further design resolution at DA stage

ac design partnership
architecture urban design planning

7.2 Indicative Floor Plans - Options 2

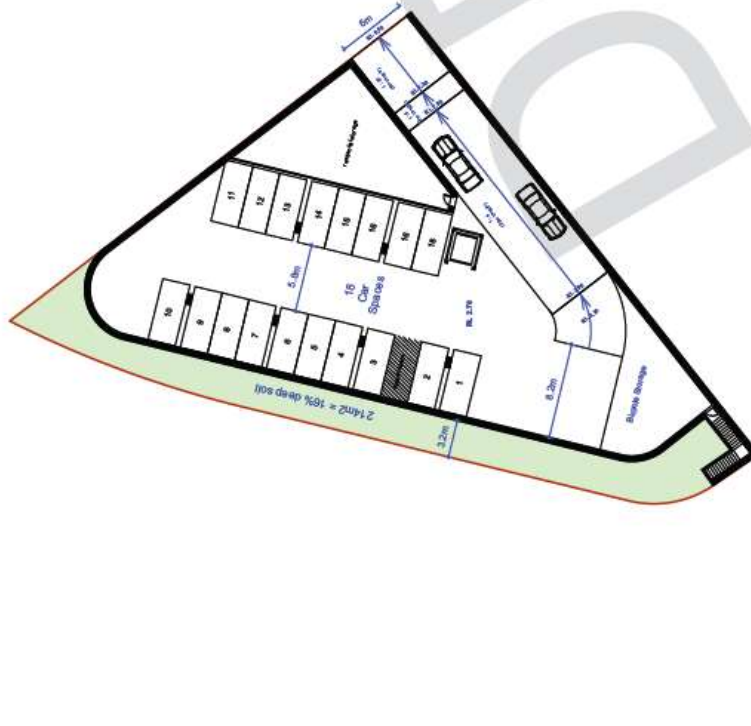

Basement Level

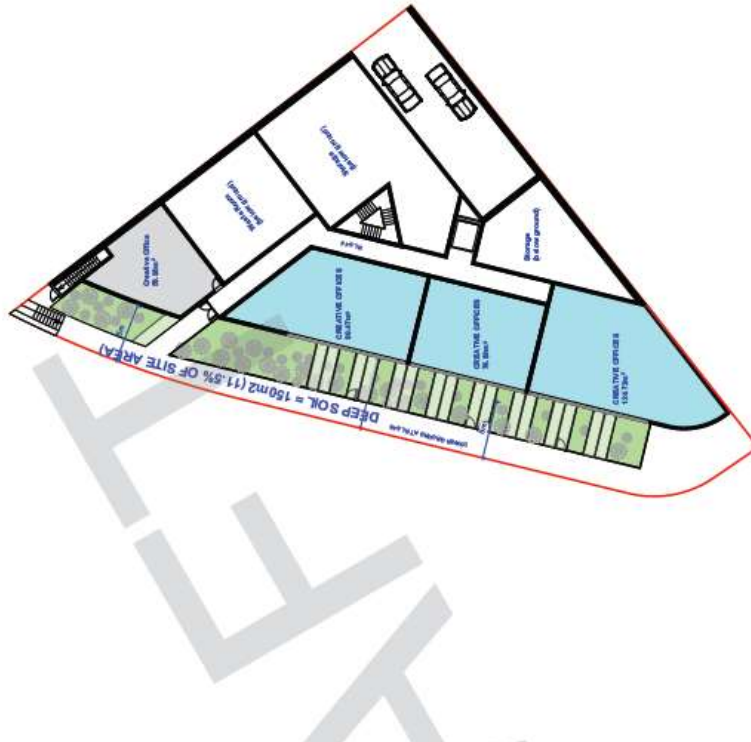

Lower Ground / Johnston's Creek Level

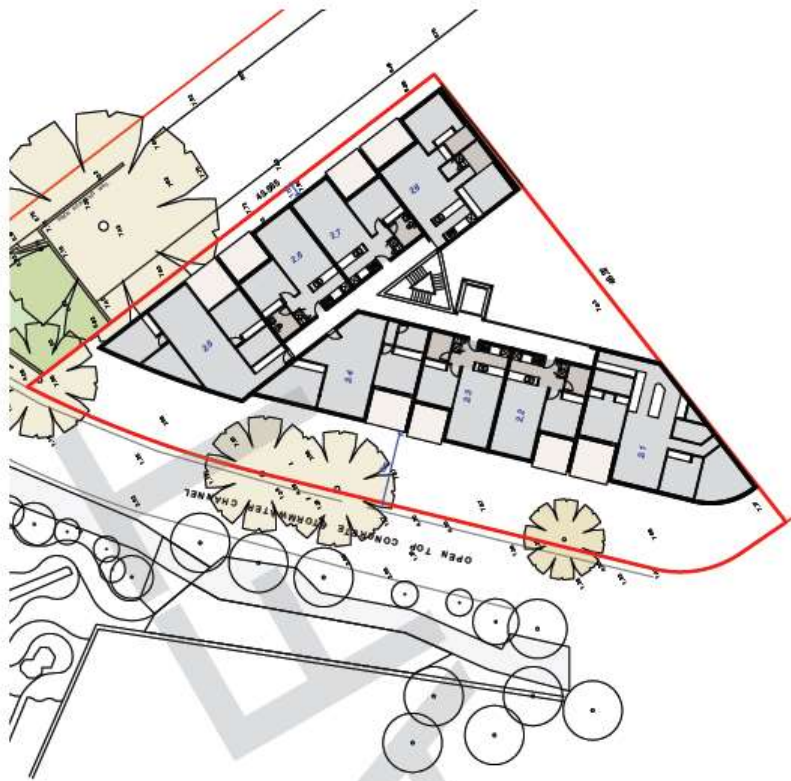

North arrow
Levels 2 - 3

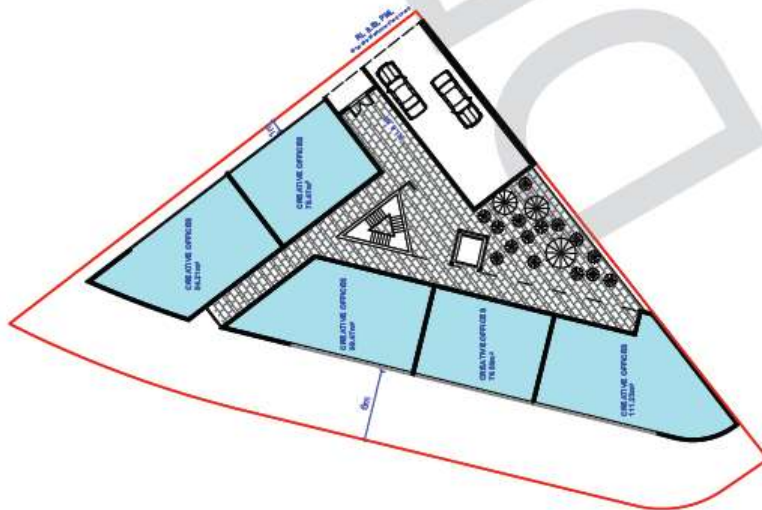

North arrow
Level 1 / Ground / Chester Street Level

Architectural drawings subject to further design resolution at DA stage

ac design partnership
architecture urban design planning

3. TRAFFIC ASSESSMENT

Road Hierarchy

The road hierarchy allocated to the road network in the vicinity of the site by the Roads and Maritime Services is illustrated on Figure 3.

Parramatta Road is classified by the RMS as a *State Road* and provides a key east-west road link in the area, linking Parramatta and the Sydney CBD. It typically carries three traffic lanes in each in the vicinity of the site, including dedicated Bus Lanes during commuter peak periods.

Pymont Bridge Road is also classified by the RMS as a *State Road* and provides another key east-west road link in the area, linking Annandale and Pymont. It typically carries two traffic lanes in each in the vicinity of the site, with Clearway restrictions apply during commuter peak periods.

Johnston Street is also classified by the RMS as a *State Road* which provides a key north-south road link in the area, linking Parramatta Road to The Crescent. It typically carries two traffic lanes in each direction in the vicinity of the site, with kerbside parking generally permitted.

Moore Street and Booth Street are classified by the RMS as *Regional Roads* which provide a local north-south *collector route* through the area, linking Annandale to Lilyfield. They typically carry one traffic lane in each direction in the vicinity of the site, with kerbside parking generally permitted on both sides of the road, subject to sign posted restrictions.

Chester Street is a local, unclassified road which is primarily used to provide vehicular and pedestrian access to frontage properties. Unrestricted kerbside parking is generally permitted on both sides of the road.

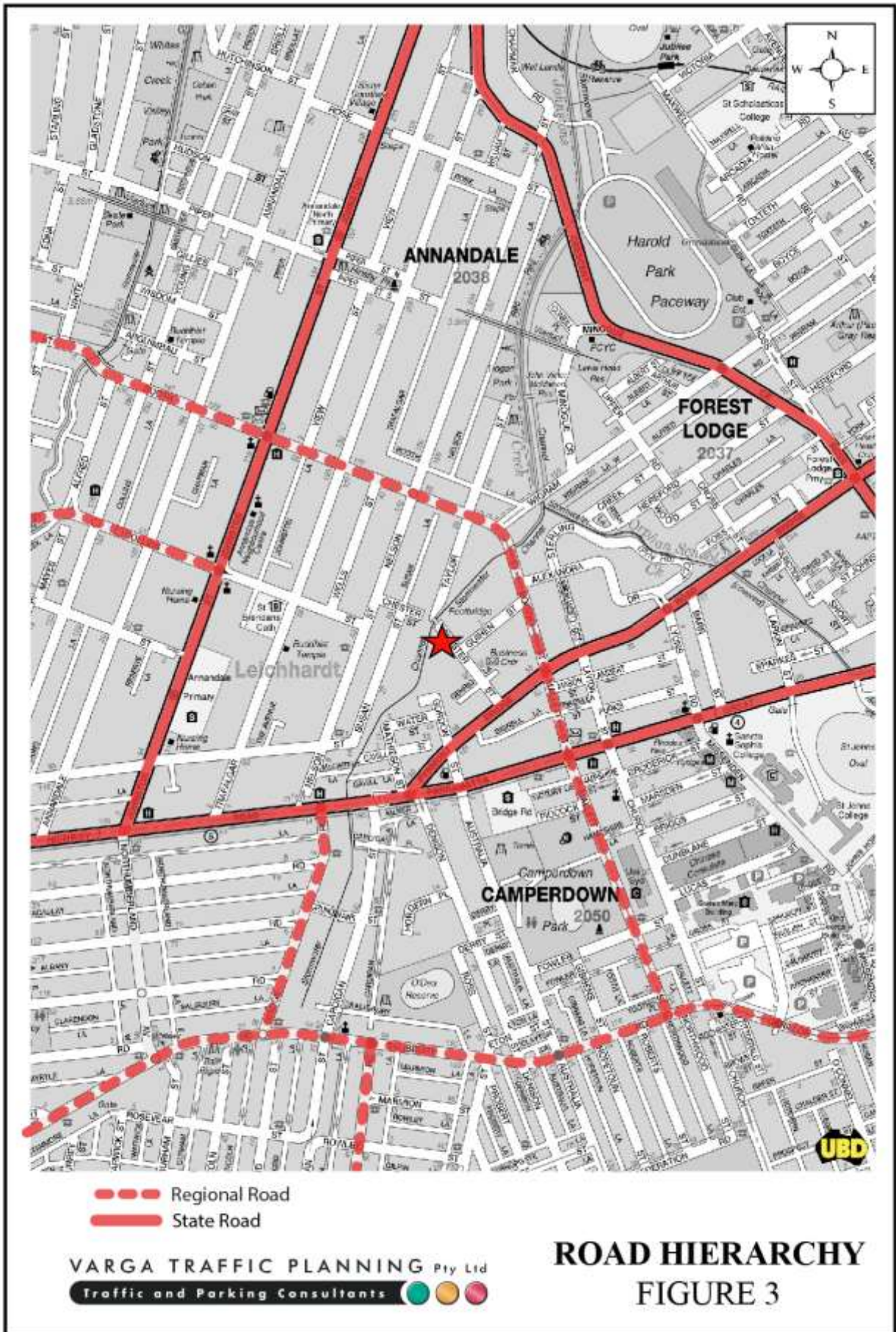

Existing Traffic Controls

The existing traffic controls which apply to the road network in the vicinity of the site are illustrated on Figure 4. Key features of those traffic controls are:

- a 60 km/h SPEED LIMIT which applies to Pymont Bridge Road
- a 50 km/h SPEED LIMIT which applies to Chester Street and all other local roads in the area
- a ROAD CLOSURE in Chester Street at its intersection with Taylor Street which precludes through traffic between Nelson Street and Pymont Bridge Road
- TRAFFIC SIGNALS in Pymont Bridge Road where it intersects with Booth Street
- a NO RIGHT TURN southbound restriction in Booth Street for traffic turning onto Pymont Bridge Road
- a NO RIGHT TURN eastbound restriction in Pymont Bridge Road for traffic turning onto Booth Street.

Existing Public Transport Services

The existing public transport services available to the site are illustrated on Figure 5.

There are currently eleven bus services which operate along Parramatta Road plus the 470 bus service which operates along Booth Street; all of which are located within approximately 400m walking distance from the site.

Notably, route M10 is part of the Sydney's *Metrobus* network that provides high-frequency, high-capacity links between key employment and growth centres across Sydney. The M10 links between Lilyfield, Leichhardt, Annandale, Pymont, Glebe, Haymarket and the Sydney CBD, operating at 10 minute intervals during commuter peak periods, 15 minute intervals during the day and 20 minute intervals at other times.

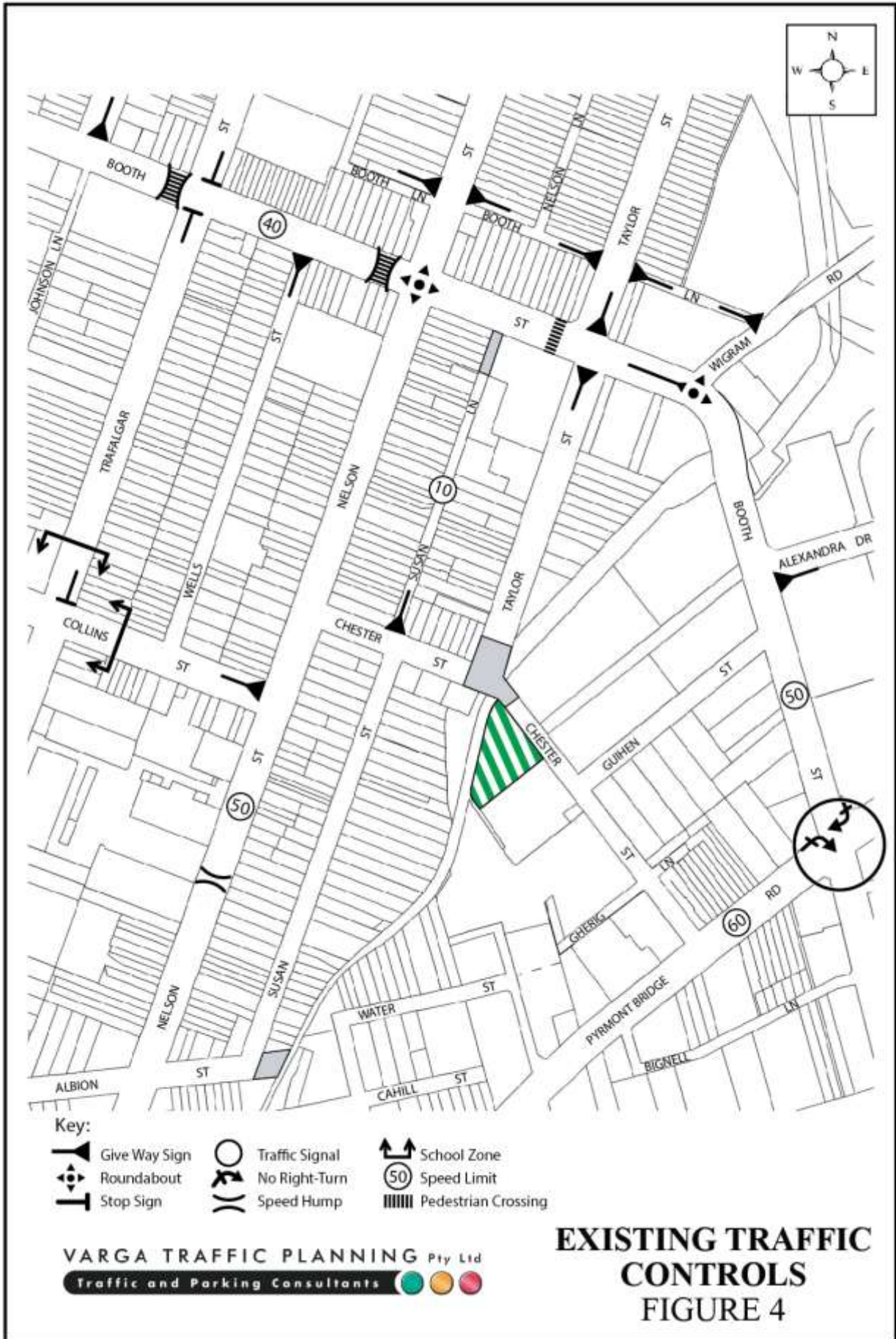

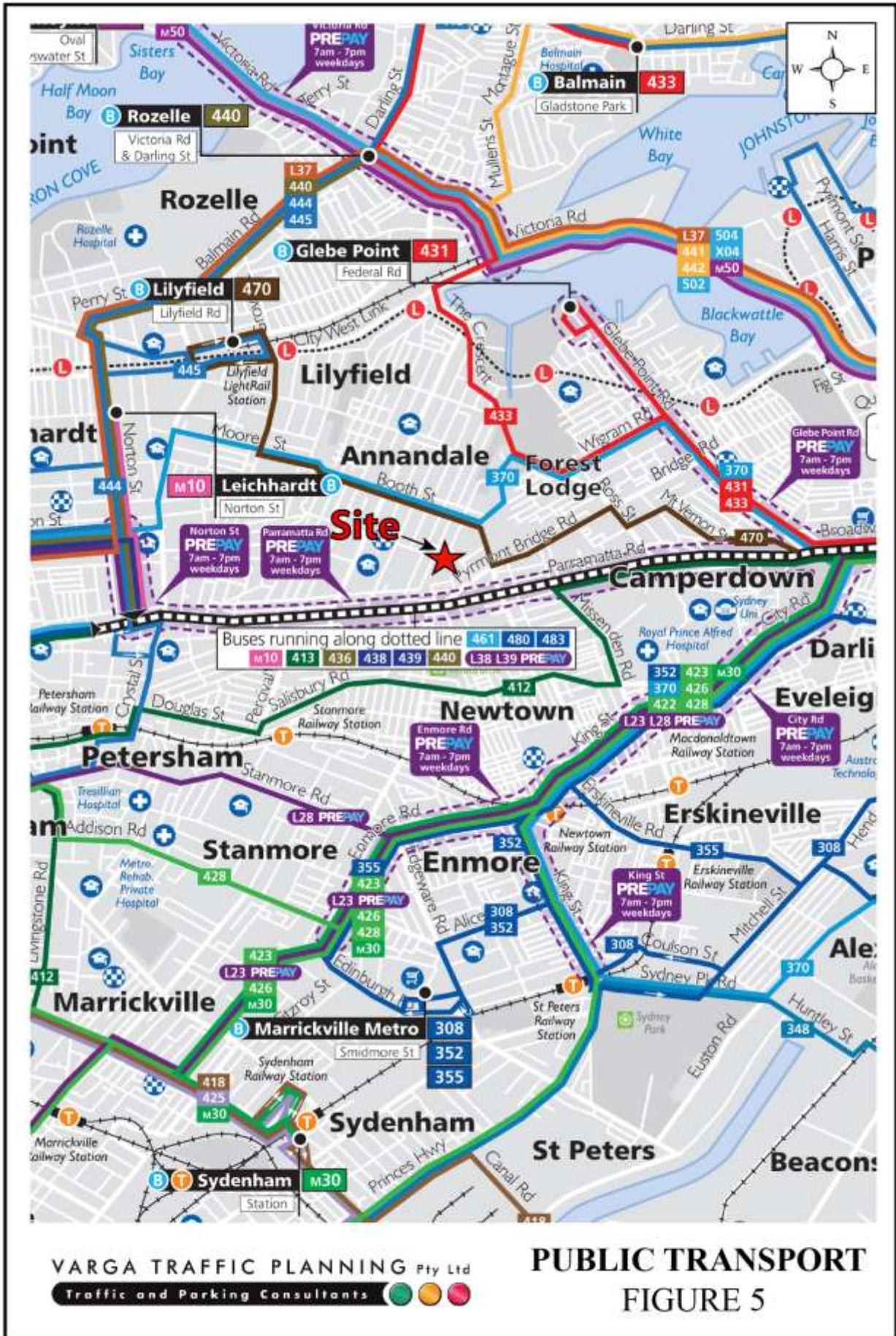

In summary there are more than 1,100 bus services operating in close proximity to the site on weekdays, decreasing to approximately 740 bus services per day on Saturdays and approximately 540 services on Sunday and public holidays, as set out below:

Bus Routes and Frequencies							
Route No.	Route	Weekdays		Saturday		Sunday	
		IN	OUT	IN	OUT	IN	OUT
413	Campsie to City via Canterbury	40	39	29	29	9	9
436	Five Dock & Rozelle to City via Leichhardt	43	40	35	35	24	25
438	Five Dock & Rozelle to City via Leichhardt	77	75	63	63	52	51
439	Five Dock & Rozelle to City via Leichhardt	23	22	22	24	16	16
440	Bronte to Rozelle	98	81	52	50	45	44
461	City Domain to Burwood	67	63	35	36	29	29
470	Lilyfield to City	87	100	58	59	40	40
480	Strathfield to Central	30	24	12	14	-	-
483	Strathfield to Central	34	31	25	27	18	21
L38	Five Dock & Rozelle to City via Leichhardt	16	15	-	-	-	-
L39	Five Dock & Rozelle to City via Leichhardt	5	8	-	-	-	-
M10	Pioneer Memorial Park to Maroubra Junction via City	65	64	38	38	37	37
TOTAL		585	562	369	375	270	272

The abovementioned bus services also connect with train services at numerous railway stations including Campsie, Burwood, Strathfield, Ashfield, Wynyard, Town Hall, Central, Martin Place and Bondi Junction Railway Stations.

In addition to the bus services, Jubilee Park Light Rail station is located approximately 1,300m walking distance north of the site with a shared Off-Road Pedestrian and Bicycle path running along Johnstons Creek which can be easily accessed directly from the northern end of Taylor Street.

On the above basis it is clear that the site is extremely well served by existing public transport and services and in an ideal location to accommodate additional residential yield.

Local Bicycle Routes

The existing bicycle routes located in the vicinity of the site are illustrated on Figure 6a and 6b. The bicycle routes are readily accessible from the subject site and provide a number of on-road bicycle routes linking the local area with the following destinations:

- Annandale Public School via Chester Street, Nelson Street and Albion Street
- TAFE Petersham via Nelson Street, Albion street, Catherine Street and Parramatta Road
- Sancta Sophia College via Pymont Bridge Road and Missenden Road
- Royal Prince Alfred Hospital via Pymont Bridge Road and Missenden Road
- Camperdown Park via Pymont Bridge Road and Australia Street
- University of Sydney via Guihen Street, Alexandria Drive, Pymont Bridge Road and Ross Street
- Glebe via Pymont Bridge Road
- Annandale via Chester Street and Nelson Street

In addition to the existing routes above the *NSW Government* is working with the Australian Government, Councils and the community to plan, prioritise and deliver better connected cycling infrastructure. A number of regional bicycle routes are proposed in the vicinity of the site as illustrated on Figure 6c (*Sydney CBD Regional Bike Network Map*).

Sydney's major employment centres attract many people travelling short distance to reach their destination. Investing in connected bike routes that are within 5km of major centres and public transport interchanges will help to increase bike riding for short trips such as the proposed site. In the longer term, a connected network of cycleways will be built to provide access to centres from a 10 kilometre catchment area which extends past the site and through to Leichhardt employment areas.

These proposed regional bicycle routes are intended to facilitate the needs of the people on bikes by connecting them to major destinations on cycleways that are separate from motor vehicles and pedestrians, thereby facilitating a quick and direct mode of transport for commuters travelling short trips (i.e. travelling to work, study, shop or socialise).

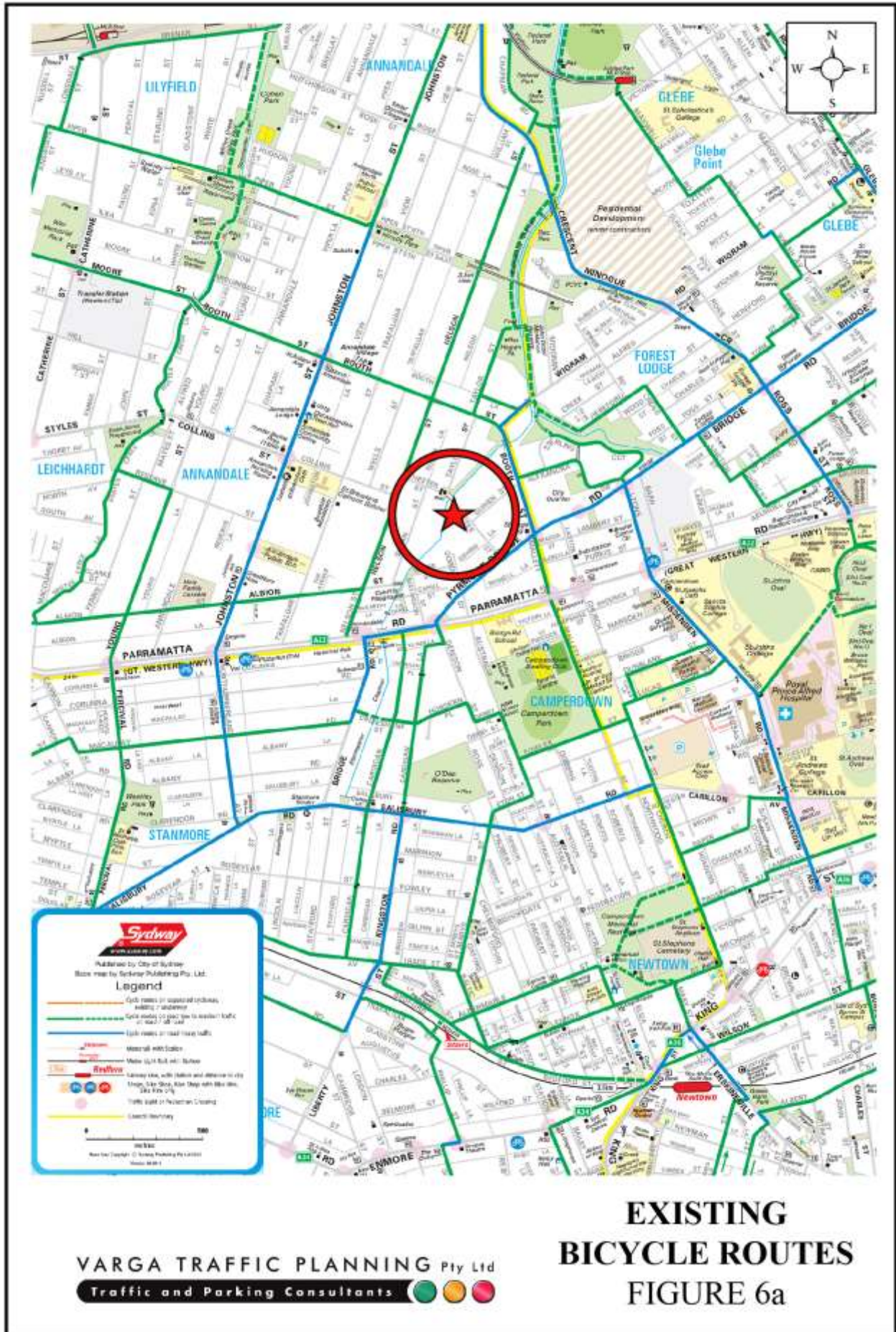

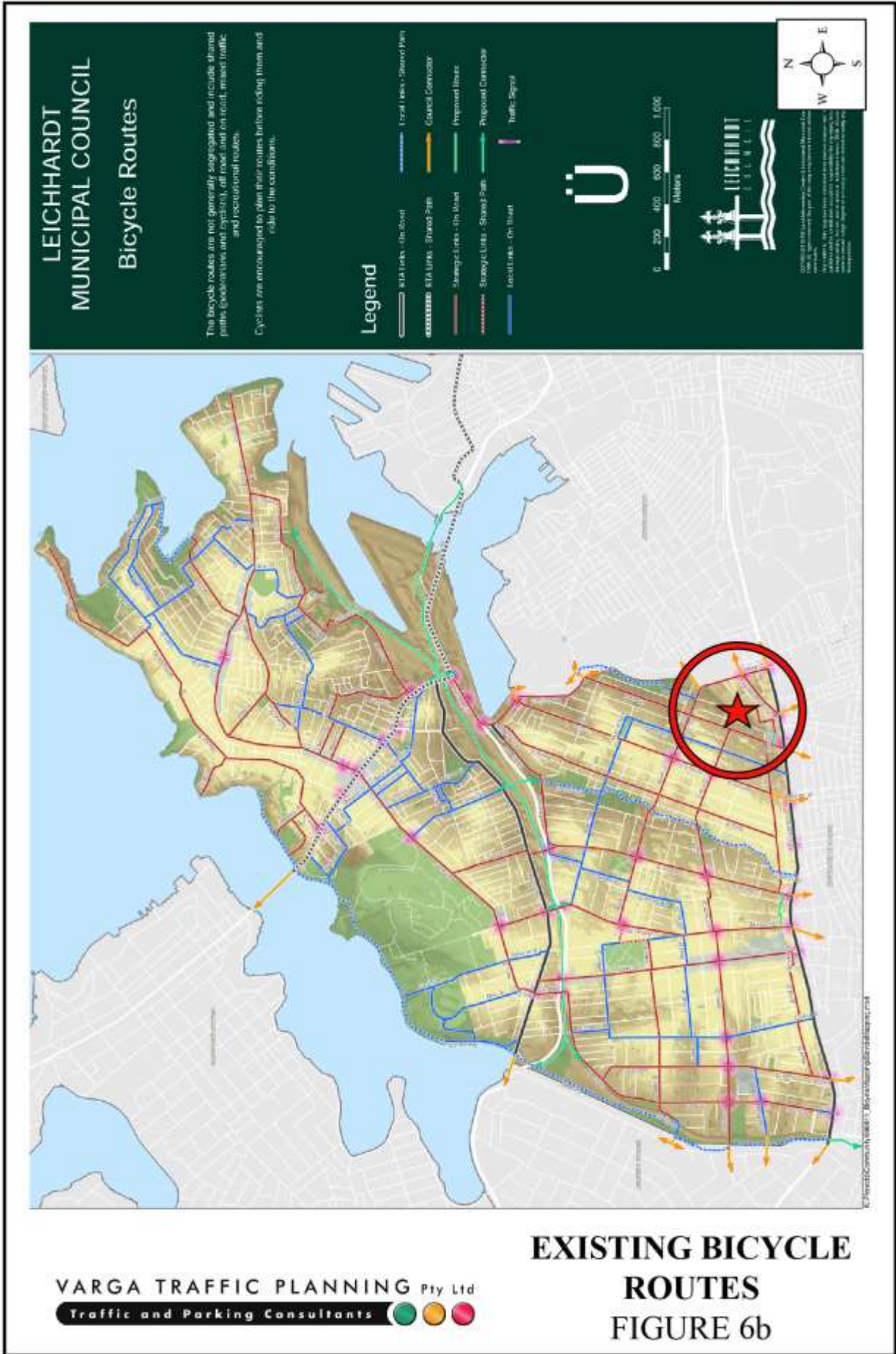



The regional bicycle routes proposed in the vicinity of the site include Leichhardt to City South / Broadway and also University of Sydney to University of NSW.

It is also noted that Sydney City Council has plans to provide more bicycle parking areas across the City to provide secure bicycle parking near locations such as:

- railway stations and major bus stops servicing across regional routes
- recreational, cultural and community facilities
- major and local shopping districts and centres
- tertiary education facilities
- dining and entertainment facilities
- around places of worship.

Parramatta Road Corridor Urban Transformation Strategy

The Parramatta Road Corridor Urban Transformation Strategy (PRCUTS) has identified a number of active transport linkages in the vicinity of the site.

A number of improvements are proposed to the active transport linkages, consistent with those improvements already identified by the State Government, City of Sydney and Leichhardt Councils. The improvement strategy identified by PRCUTS is illustrated on Figure 7 and include the following:

- C4 Pyrmont Bridge Road public domain improvements including new street trees, paving and bike parking
- C5 Australia Street improvements to pedestrian amenity to connect with Newtown Station
- C6 improve Chester Street and Taylor Street connection to Johnston Creek
- C7 improve north-south regional cycle connections across Parramatta Road and

NEW PARRAMATTA RD

Camperdown | Transport Improvements

Potential Improvements	
C1	Improve east-west connections by extending Cambridge Place and Hickson Place
C2	Investigate formalising bicycle lanes as well as road shoulders
C3	Provide Pyrmont Stage Road, Millers Street and South Street as local streets to increase general traffic flow and use on-street parking for all users
C4	Pyrmont Bridge Road public domain improvements between Pyrmont Bridge Road and Cambridge Place including tree street tree planting, paving and bike parking
C5	Australia Street improvements to pedestrian amenity to connect to Newcastle Station
C6	Improve Charles Street and Taylor Street connections to Sydney Creek
C7	Improve north-south regional cycle connectors across Parramatta Road
C8	Provide access improvements to Scott Street between Wigram Road and Pyrmont Bridge Road
C9	Provide bus priority measures where possible along Parramatta Road from Burwood to the Sydney CBD
C10	Delivery of Parramatta Road on-street Rapid Transit between Scott Street / Burwood and the Sydney CBD including more frequent services across the peak, weekends and weekdays, more reliable services with consolidated rapid transit stops every 800m to 1km.

Legend	
Green arrow	Coloured Active Transport Improvement
Red arrow	Existing Open Space
Blue arrow	Parramatta Public Transport Improvement
Yellow arrow	Community
Light blue arrow	Parramatta Road/Highway Improvement
Dark blue arrow	Employment
Light green arrow	Commercial
Red dashed line	Parramatta Road Corridor Boundary
Blue dashed line	Residential
Green dashed line	Mixed Use
Yellow dashed line	MS Motorway
Blue dashed line	Tier 2 Station
Blue dashed line	Tier 1 Station
Blue dashed line	Includes Zone of Future Super Stop
Blue dashed line	Drainage

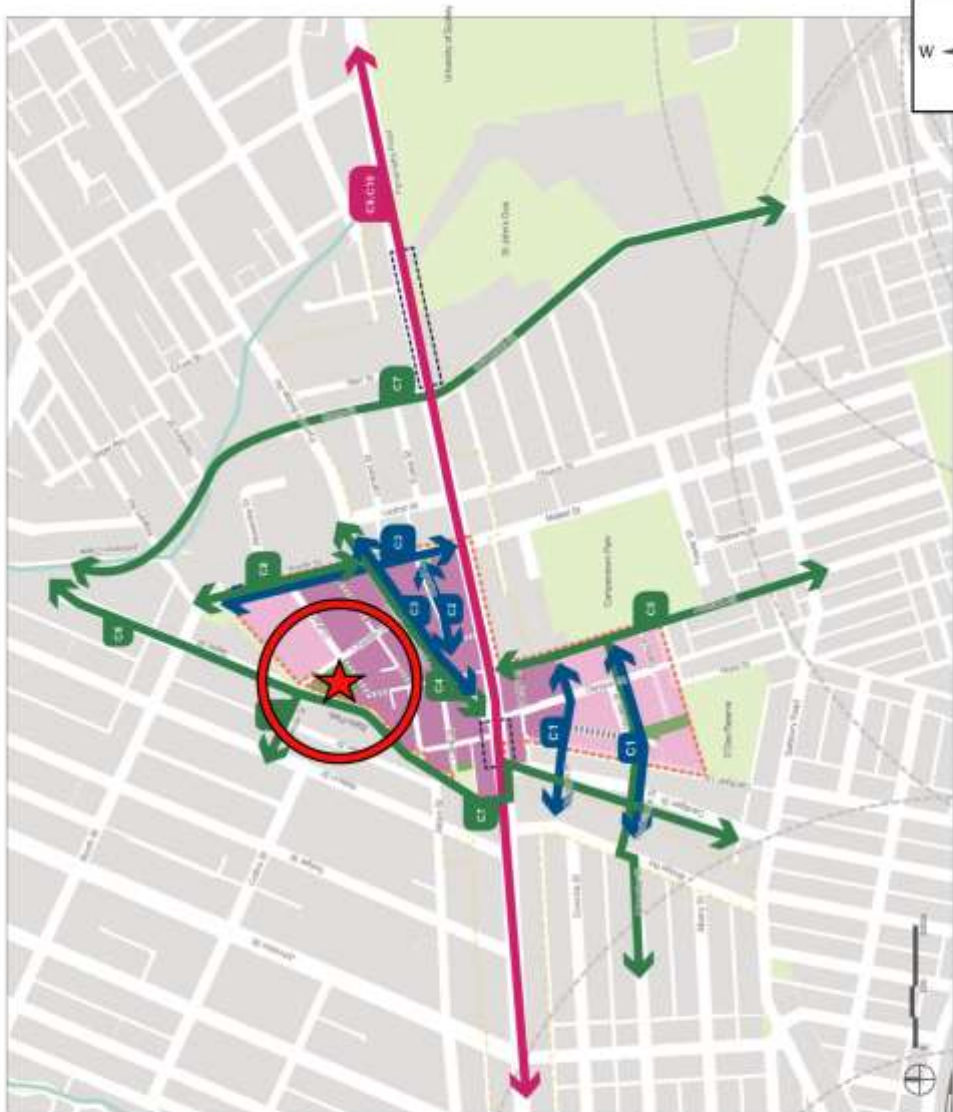

Figure B5 Camperdown Predict transport improvements [Source: NECTM, 2010 and BaseMap - Cox, Oculus, CHM, 2010]

- C8 pedestrian access improvements to Booth Street between Wigram Road and Pyrmont Bridge Road.

The PRCUTS also proposes to provide improved bus priority measures wherever possible along Parramatta Road to further enhance the efficiency of the extensive high frequency bus routes provided in that important corridor.

The subject site is located in close proximity to many of the active transport linkages which have been identified by PRCUTS. In particular, it is noted that:

- the subject site is located directly adjacent to the active transport linkages proposed along Johnstons Creek and the improved linkages proposed between Chester Street and Taylor Street. These improvements would facilitate reduced private car dependency of future residents of the site by providing improved access to alternate and active forms of transport such as walking and cycling, as well as improved access to bus services along Parramatta Road
- improvements to pedestrian amenity along Australia Street would encourage active and alternate forms of transport by enhancing the opportunities for future residents to walk the 1.4 km distance to Newtown Railway Station, and
- improved north-south regional cycle connections across Parramatta Road would also reduce private car dependency of future residents by providing improved opportunities for intra-regional cycling.

Travel Plan

A Travel Plan is a package of actions designed to encourage safe, healthy and sustainable travel options. The objectives of a Travel Plan are to remove barriers to active travel for all users of developments and to maximize the number of people who walk, cycle or take public transport to and from the development.

A key feature of a Travel Plan includes a plan detailing the location of all public transport services as well as key facilities such as banks, post office etc. located within a 5 minute and

10 minute walking radius of the site. In this regard, it is noted that the site is located within easy walking distance to a range of shops and services as well as bus services which a large proportion of future employees/residents are likely to utilise for their weekday trips to/from work and/or educational establishment.

In addition, the development will provide a generous quantity of bicycle and motorcycle parking for future employees and residents which further shows the commitment of the development to a more sustainable approach to travel.

WestConnex M4-M5 Link

In November 2016, updated design features for the M4-M5 Link were announced including a main tunnel consisting of four traffic lanes in each direction.

Whilst Government and the RMS were originally considering an on/off ramp in the Camperdown precinct, the updated design for the WestConnex M4 East no longer includes any on/off ramps in the immediate vicinity of the site. The future tunnel will be located several hundred metres to the west of the site and approximately 60m below ground.

As such, there is *not* expected to be any permanent traffic implications on the proposed development as a consequence of the WestConnex.

Notwithstanding, it is understood that a strip of land located between 162-196 Parramatta Road has been acquired by the RMS for a temporary construction 'dive site'. Whilst the 'dive site' will prohibit the redevelopment of that part of the Camperdown precinct for several years it is also *not* expected to result in any unacceptable traffic implications on the proposed development.

Existing Traffic Conditions

An indication of the existing traffic conditions on the road network in the vicinity of the site is provided by peak period traffic surveys undertaken as part of this original traffic study.

The traffic surveys were undertaken at the Pymont Bridge Road and Chester Street intersection as well as the Booth Street and Guihen Street intersection. The results of the traffic surveys are reproduced in full in Appendix A and reveal that:

- two-way traffic flows in Pymont Bridge Road are typically in the order of 800-1,000 vehicles per hour (vph) during peak periods
- two-way traffic flows in Booth Street are also typically in the order of 800-1,000 vph during peak periods.
- two-way traffic flows in Chester Street are significantly lower, typically in the order of 50-100 vph during commuter peak periods.

Projected Traffic Generation

An indication of the traffic generation potential of the planning proposal is provided by reference to the Roads and Maritime Services publication *Guide to Traffic Generating Developments, Section 3 - Landuse Traffic Generation (October 2002)* and the updated traffic generation rates in the recently published RMS *Technical Direction (TDT 2013/04a)* document.

The *TDT 2013/04a* document specifies that it replaces those sections of the RMS *Guidelines* indicated, and that it must be followed when RMS is undertaken trip generation and/or parking demand assessments.

The RMS *Guidelines* and the updated *TDT 2013/04a* are based on extensive surveys of a wide range of land uses and nominates the following traffic generation rates relating to permissible uses on the site:

Industrial – Warehouse

0.5 peak hour vehicle trips/100m² GFA

Industrial – Factory

1.0 peak hour vehicle trips/100m² GFA

Office Premises

2.0 peak hour vehicle trips/100m² GFA

As the future non-residential tenancies of the development are expected to be industrial/creative offices, for the purposes of this assessment, the abovementioned “office premises” traffic generation rate is considered the most appropriate.

Notwithstanding, the “office premises” traffic generation rate of *2.0 peak hour vehicle trip per 100m²* assumes off-street parking is provided at the rate of *1 space per 40m²*. As detailed in Chapter 4 of this report however, Council’s *LDCP 2013* nominates a *constrained* off-street parking rate for office uses of *1 space per 80m² (max)*, due to the site’s excellent accessibility to alternative transport options – i.e. *half* of the typical parking rate for office uses.

For the purposes of this assessment therefore, a traffic generation rate of *1.0 peak hour vehicle trip per 100m²* has been adopted for the non-residential component of the planning proposal which is *half* of the typical traffic generation rate for office uses.

Furthermore, as noted in the foregoing, given the site’s proximity to a number of tertiary educational establishments and an extensive range of alternate transport options, it is recommended that off-street car parking for the residential component (i.e. student accommodation) is intentionally *constrained* and limited to courier vehicles, service vehicles, disabled vehicles and a manager’s vehicle only. It is also worth noting that Council’s *LDCP 2013* and *Parramatta Road Corridor Urban Transformation Strategy: Planning and Design Guidelines (Nov 2016)* specifies that the minimum off-street parking rate for “bed-sit/studio apartments” is *nil*.

If it is assumed that all of the non-commercial parking spaces (excluding the on-site manager’s space) are accessed once during a two-hour period in the morning and afternoon, then the residential (student accommodation) component has a traffic generation potential of just 2 peak hour vehicle trips.

Application therefore of the above traffic generation rates to the various components of the planning proposal yields a traffic generation potential of approximately 12 vehicle trips per hour during the weekday commuter peak periods as set out below:

Projected Future Traffic Generation Potential

Non-residential (989m ²):	9.9 peak hour vehicle trips
Student accommodation (4 car spaces):	2.0 peak hour vehicle trips
TOTAL: TRAFFIC GENERATION POTENTIAL:	11.9 peak hour vehicle trips

That projected future level of traffic generation potential should however, be offset or *discounted* by the volume of traffic which could reasonably be expected to be generated by a scheme under the current planning controls which apply to the site, in order to determine the *nett increase (or decrease)* in traffic generation potential expected to occur as a consequence of the planning proposal.

In order to compare “apples with apples”, application of the abovementioned traffic generation rate of *1.0 peak hour vehicle trip per 100m²* to the potential for 1,307m² GFA of floor area applying current planning controls yields a traffic generation potential of 13 peak hour vehicle trips.

Accordingly, it is likely that the planning proposal will result in a slight *nett reduction* in the traffic generation potential of the site of 1 vph when compared to a scheme under the current planning controls, as set out below:

**Projected Nett Reduction in Peak Hour Traffic Generation Potential
of the Site as a consequence of the Planning Proposal**

Planning Proposal Projected Future Traffic Generation Potential:	11.9 vehicle trips per hour
Less Permissible Scheme Traffic Generation Potential:	-13.0 vehicle trips per hour
NETT REDUCTION IN TRAFFIC GENERATION POTENTIAL:	-1.1 vehicle trips per hour

For the purposes of this assessment however, it has been assumed that *all* of the projected future traffic flows of 12 peak hour vehicle trips will be new or *additional* to the existing traffic flows currently using the adjacent road network.

That projected level of traffic activity as a consequence of the planning proposal is minimal and will clearly not have any unacceptable traffic implications in terms of road network capacity, as is demonstrated by the following section of this report.

Traffic Implications - Road Network Capacity

The traffic implications of development proposals primarily concern the effects that any *additional* traffic flows may have on the operational performance of the nearby road network. Those effects can be assessed using the SIDRA program which is widely used by the RMS and many LGA's for this purpose. Criteria for evaluating the results of SIDRA analysis are reproduced in the following pages.

The results of the SIDRA analysis of the in Pymont Bridge Road and Chester Street intersection are summarised on Table 3 below, revealing that:

- the Pymont Bridge Road and Chester Street intersection currently operates at *Level of Service "A"* under the existing traffic demands with total average vehicle delays in the order of *less than* 1 second/vehicle
- under the projected future traffic demands expected to be generated by Option 1 of the planning proposal, the intersection would continue to operate at *Level of Service "A"* during the AM and PM commuter peak periods, with increases in average vehicle delays of *less than* 1 second/vehicle.
- under the projected future traffic demands expected to be generated by Option 2 of the *planning proposal*, the intersection would also continue to operate at *Level of Service "A"* during the AM and PM commuter peak periods, with increases in average vehicle delays of *less than* 1 second/vehicle.

The results of the SIDRA analysis of the Booth Street and Guihen Street intersection are summarised on Table 3 below, revealing that:

- the Booth Street and Guihen Street intersection currently operates at *Level of Service "A"* under the existing traffic demands with total average vehicle delays in the order of *less than* 1 second/vehicle
- under the projected future traffic demands expected to be generated by Option 1 of the planning proposal, the intersection would continue to operate at *Level of Service "A"*

during the AM and PM commuter peak periods, with *zero* increases in average vehicle delays.

- under the projected future traffic demands expected to be generated by Option 2 of the *planning proposal*, the intersection would also continue to operate at *Level of Service “A”* during the AM and PM commuter peak periods, with *zero* increases in average vehicle delays.

Table 3 – SIDRA INTERSECTION 8 Assessment Results

Key Indicators	Existing		Option 1 Projected Future Traffic Demand		Option 2 Projected Future Traffic Demand	
	AM	PM	AM	PM	AM	PM
Pyrmont Bridge Rd & Chester St						
LOS	A	A	A	A	A	A
DOS	0.120	0.162	0.121	0.162	0.121	0.163
AVD (Sec/Veh)	0.7	0.9	0.7	1.0	0.8	1.0
Booth St & Guihen St						
LOS	A	A	A	A	A	A
DOS	0.334	0.273	0.335	0.274	0.336	0.274
AVD (Sec/Veh)	0.4	0.8	0.5	0.8	0.5	0.8

PBR_CHEX

PBR_CHEP (OPT1)

PBR_CHEP (OPT2)

The results of the intersection capacity analysis reveal that the projected additional traffic flows for the two proposed options of the development proposal compared with the existing scenario will not have *any* appreciable effect whatsoever on the operational performance of the intersections located in the vicinity of the site. Furthermore, all of those intersections are expected to continue to operate at current *Levels of Service*, with minimal delays on all approaches, and with *negligible increases* in total average vehicle delays.

It is therefore reasonable to conclude that the proposed development will not have any unacceptable implications in terms of road network capacity.

Criteria for Interpreting Results of Sidra Analysis

1. *Level of Service (LOS)*

LOS	Traffic Signals and Roundabouts	Give Way and Stop Signs
'A'	Good operation.	Good operation.
'B'	Good with acceptable delays and spare capacity.	Acceptable delays and spare capacity.
'C'	Satisfactory.	Satisfactory but accident study required.
'D'	Operating near capacity.	Near capacity and accident study required.
'E'	At capacity; at signals incidents will cause excessive delays. Roundabouts require other control mode.	At capacity and requires other control mode.
'F'	Unsatisfactory and requires additional capacity.	Unsatisfactory and requires other control mode.

2. *Average Vehicle Delay (AVD)*

The AVD provides a measure of the operational performance of an intersection as indicated on the table below which relates AVD to LOS. The AVD's listed in the table should be taken as a guide only as longer delays could be tolerated in some locations (ie inner city conditions) and on some roads (ie minor side street intersecting with a major arterial route).

Level of Service	Average Delay per Vehicle (secs/veh)	Traffic Signals, Roundabout	Give Way and Stop Signs
A	less than 14	Good operation.	Good operation.
B	15 to 28	Good with acceptable delays and spare capacity.	Acceptable delays and spare capacity.
C	29 to 42	Satisfactory.	Satisfactory but accident study required.
D	43 to 56	Operating near capacity.	Near capacity and accident study required.
E	57 to 70	At capacity; at signals incidents will cause excessive delays. Roundabouts require other control mode.	At capacity and requires other control mode.

3. *Degree of Saturation (DS)*

The DS is another measure of the operational performance of individual intersections.

For intersections controlled by traffic signals¹ both queue length and delay increase rapidly as DS approaches 1, and it is usual to attempt to keep DS to less than 0.9. Values of DS in the order of 0.7 generally represent satisfactory intersection operation. When DS exceeds 0.9 queues can be anticipated.

For intersections controlled by a roundabout or GIVE WAY or STOP signs, satisfactory intersection operation is indicated by a DS of 0.8 or less.

¹ The values of DS for intersections under traffic signal control are only valid for cycle length of 120 secs.

4. PARKING IMPLICATIONS

Existing Kerbside Parking Restrictions

The existing kerbside parking restrictions which apply to the road network in the vicinity of the site comprise:

- generally UNRESTRICTED kerbside parking along both sides of Chester Street and Guihen Street, including along the entire site frontage, and throughout the local area
- BUS ZONES located at regular intervals along both sides of Booth Street.

Off-Street Car Parking Provisions

There are two documents which provide parking rates for the proposed land uses on the site; Council's *Leichhardt Development Control Plan 2013 – Part C1.11, Parking*, the *SEPP (Affordable Rental Housing) 2009* and the *Parramatta Road Corridor Urban Transformation Strategy: Planning and Design Guidelines (Nov 2016)*.

As noted in the traffic assessment in Chapter 3 of this report, the future non-residential tenancies of the development are expected to be industrial/creative offices, therefore for the purposes of this assessment, the following “commercial office” off-street parking rates are considered the most appropriate.

Council's *LDCP 2013* document specifies the following off-street parking rates:

Office	1 space per 100m ² (min)	&	1 space per 80m ² (max)
Residential			
Bed-site/studio:	Nil spaces (min)	&	0.5 spaces per dwelling (max)
One bedroom dwelling:	1 space per 3 dwellings (min)	&	0.5 spaces per dwelling (max)
Two bedroom dwelling:	1 space per 2 dwellings (min)	&	1 space per dwelling (max)
Three bedroom dwelling:	1 space per dwelling (min)	&	1.2 spaces per dwelling (max)
Visitors:	1 space per 11 dwellings (min)	&	0.125 spaces per dwelling (max)

The *Parramatta Road Corridor Urban Transformation Strategy: Planning and Design Guidelines (Nov 2016)* document specifies the following off-street parking rates:

Residential

Studio dwelling:	Nil spaces per dwelling (max)
One bedroom dwelling:	0.3 spaces per dwelling (max)
Two bedroom dwelling:	0.7 space per dwelling (max)
Three bedroom dwelling:	1 space per dwelling (max)
Visitors:	Nil spaces per dwelling (max)

Commercial

1 space per 150m²

A comparison of the parking rates provided within the two documents is illustrated in the table below.

Car Parking Rate Comparison		
Land Use	LDCP 2013	PRCUTS 2016
Residential Option 1 – 26 apartments	13 residential & 2 visitor spaces	15 residential & 0 visitor spaces
Residential Option 2 – 83 student rooms	Nil spaces	Nil spaces
Non-Residential – 989m ²	12 spaces	7 spaces

By way of comparison, reference is also made to a number of existing student accommodation developments within close proximity to tertiary educational establishments.

Provider	Address	No. of Beds	Approx. Walking Distance to the Closest University	No. of Car Parking Spaces	No. of Motorcycle Parking Spaces
Iglu – Redfern	66 Regent St, Redfern	370	900m (University of Sydney, Main Campus)	0	-
Iglu - Broadway	9 Kensington St, Chippendale	271	280m (University of Technology Sydney)	0	-
Iglu - Central	1 Regent St, Chippendale	98	150m (University of Technology Sydney)	0	0
Iglu – Central Park	6 Central Park Ave, Chippendale	770	250m (University of Technology Sydney)	0	-
Scape – Abercrombie Street	267-269 Abercrombie St, Darlington	54	450m (University of Sydney, Main Campus)	0	-
Urbanest – Cleveland Street	142 Abercrombie St, Redfern	461	885m (University of Sydney, Main Campus)	0	0
Unilodge @ UNSW	1 Lorne Ave, Kensington	231	700m (University of NSW)	0	-
Urbanest – Wattle Street	473 Wattle Street, Ultimo	665	300m (University of Technology Sydney)	0	86
Urbanest – Quay Street	83 Quay Street, Haymarket	334	260m (Sydney TAFE)	0	0

As can be seen, the 9 existing student accommodation developments referred to in the table provide *zero* off-street car parking for residents.

Based on the various parking rates within the *LDCP 2013* and *PRCUTS 2016*, it is recommended that off-street parking be provided at the following rates:

Non-residential (989m²)	1 space per 80m ²
Student accommodation (83 rooms)	1 manager's space

Application of the above recommended parking rates to the various components of the planning proposal yields an off-street parking of 14 spaces, comprising 13 non-residential spaces and 1 on-site manager's space.

The concept plans propose a total of 18 spaces within a new single-level basement car parking area, comprising 13 non-residential spaces, 1 manager's space, 1 courier space, 1 service vehicle space and 2 disabled spaces, thereby satisfying the above requirements.

The geometric design layout of the future car parking facilities will ultimately be designed to comply with Standards Australia publication *Parking Facilities Part 1 - Off-Street Car Parking AS2890.1* and *Parking Facilities Part 6 - Off-Street Parking for People with Disabilities AS2890.6*.

Off-street Motorcycle and Bicycle Parking Requirements

The motorcycle and bicycle parking requirements applicable to the development proposal are also specified in Council's *Leichhardt Development Control Plan 2013 – Part C1.11, Parking* document in the following terms:

Motorcycle

1 space for developments that require between 1 to 10 vehicle spaces and 5% of the required vehicle parking thereafter

Bicycle

Student Accommodation

Residents: 1 bicycle space per 6 rooms

Visitors: 1 bicycle space per 6 rooms

Commercial

Staff: 1 bicycle space per 10 staff
 Customers: 1 bicycle space per 400m²

Application of the above motorcycle and bicycle parking rates to the various components of the planning proposal yields a minimum off-street parking requirement of 15 motorcycle spaces and 18 bicycle spaces as set out in the table below.

Motorcycle & Bicycle Parking		
Land Use	Rate	Requirement
Motorcycles - Residential	1 space per 6 rooms*	14 motorcycle spaces
Motorcycles – Non-Residential	1 space (between 1-10 car spaces)	1 motorcycle space
Bicycles - Residential	1 space per 6 rooms	14 bicycle spaces
Bicycles – Non-Residential	1 space per 10 staff & 1/400m ²	4 bicycle spaces

* recommended rate based on bicycle rate

The concept plans propose a total of 18 motorcycle spaces and 21 bicycle spaces within a new single-level basement car parking area, thereby satisfying the above requirements.

The geometric design of the motorcycle and bicycle parking requirements will also ultimately be designed in accordance with AS2890 requirements.

Conclusion

The foregoing has found that by *constraining* the provision of off-street parking, particularly the residential component, the planning proposal will likely result in a slight *nett reduction* in the traffic generation potential of the site of 1 vph when compared to a hypothetical scheme under the current planning controls. As such, no infrastructure or road upgrades will be required.

Furthermore, the proposed development satisfies the minimum off-street bicycle and motorcycle parking requirements as well as providing adequate off-street car parking, noting the site’s proximity to a number of tertiary educational establishments and an extensive range of alternate transport options.

Whilst regular residential apartments *and* student accommodation options were both assessed, it is considered that Option 2 – student accommodation – is considered to be the preferred type of residential as it more closely aligns with GSC and NSW State Government objectives of the Camperdown Health-Education Super Precinct, *and*, will add *nil* additional vehicle movements to the surrounding road network.

It is therefore reasonable to conclude that the planning proposal will not have any unacceptable implications in terms of road network capacity or off-street parking/loading requirements.

APPENDIX A

TRAFFIC SURVEY DATA



R.O.A.R. DATA

Reliable, Original & Authentic Results

Ph.88196847, Mob.0418-239019

Client : Varga Traffic Planning

Job No/Name : 6492 ANNANDALE Chester St

Day/Date : Tuesday 20th June 2017

Lights	WEST		NORTH		EAST		TOT
	Pyrmont Br		Chester St		Pyrmont Br		
	I	L	R	L	R	I	
0700 - 0715	114	3	4	4	1	48	174
0715 - 0730	104	8	5	3	1	45	166
0730 - 0745	125	1	10	5	1	53	195
0745 - 0800	132	2	6	2	2	74	218
0800 - 0815	94	1	7	2	6	78	188
0815 - 0830	105	2	7	2	4	58	178
0830 - 0845	109	2	5	4	1	66	187
0845 - 0900	115	3	7	4	9	63	201
Per End	898	22	51	26	25	485	1507

Heavies	WEST		NORTH		EAST		TOT
	Pyrmont Br		Chester St		Pyrmont Br		
	I	L	R	L	R	I	
0700 - 0715	2	0	0	0	0	0	2
0715 - 0730	3	0	0	0	0	0	3
0730 - 0745	2	0	0	0	0	1	3
0745 - 0800	0	0	0	0	0	0	0
0800 - 0815	1	0	0	0	0	3	4
0815 - 0830	1	0	0	0	0	1	2
0830 - 0845	0	0	0	0	0	2	2
0845 - 0900	2	0	0	0	0	1	3
Per End	11	0	0	0	0	8	19

Combined	WEST		NORTH		EAST		TOT
	Pyrmont Br		Chester St		Pyrmont		
	I	L	R	L	R	I	
0700 - 0715	116	3	4	4	1	48	176
0715 - 0730	107	8	5	3	1	45	169
0730 - 0745	127	1	10	5	1	54	198
0745 - 0800	132	2	6	2	2	74	218
0800 - 0815	95	1	7	2	6	81	192
0815 - 0830	106	2	7	2	4	59	180
0830 - 0845	109	2	5	4	1	68	189
0845 - 0900	117	3	7	4	9	64	204
Per End	909	22	51	26	25	493	1526

Lights	WEST		NORTH		EAST		TOT
	Pyrmont Br		Chester St		Pyrmont Br		
	I	L	R	L	R	I	
0700 - 0800	475	14	25	14	5	220	753
0715 - 0815	455	12	28	12	10	250	767
0730 - 0830	456	6	30	11	13	263	779
0745 - 0845	440	7	25	10	13	276	771
0800 - 0900	423	8	26	12	20	265	754

Heavies	WEST		NORTH		EAST		TOT
	Pyrmont Br		Chester St		Pyrmont Br		
	I	L	R	L	R	I	
0700 - 0800	7	0	0	0	0	1	8
0715 - 0815	6	0	0	0	0	4	10
0730 - 0830	4	0	0	0	0	5	9
0745 - 0845	2	0	0	0	0	6	8
0800 - 0900	4	0	0	0	0	7	11

Combined	WEST		NORTH		EAST		TOT
	Pyrmont Br		Chester St		Pyrmont		
	I	L	R	L	R	I	
0700 - 0800	482	14	25	14	5	221	761
0715 - 0815	461	12	28	12	10	254	777
0730 - 0830	460	6	30	11	13	268	788
0745 - 0845	442	7	25	10	13	282	779
0800 - 0900	427	8	26	12	20	272	765

PEAK HR	456	6	30	11	13	263	779
----------------	------------	----------	-----------	-----------	-----------	------------	------------

PEAK HR	4	0	0	0	0	5	9
----------------	----------	----------	----------	----------	----------	----------	----------

PEAK HR	460	6	30	11	13	268	788
----------------	------------	----------	-----------	-----------	-----------	------------	------------

Peds	WEST		NORTH		EAST		TOT
	Pyrmont Br	Chester St	Pyrmont Br	Chester St	Pyrmont Br	Chester St	
0700 - 0715	0	1	2	0	0	0	3
0715 - 0730	0	2	1	0	0	0	3
0730 - 0745	1	5	0	0	0	0	6
0745 - 0800	0	5	1	0	0	0	6
0800 - 0815	0	5	0	0	0	0	5
0815 - 0830	0	4	4	0	0	0	8
0830 - 0845	0	1	0	0	0	0	1
0845 - 0900	0	12	1	0	0	0	13
Per End	1	35	9	0	0	0	45

Peak Per	WEST		NORTH		EAST		TOT
	Pyrmont Br	Chester St	Pyrmont Br	Chester St	Pyrmont Br	Chester St	
0700 - 0800	1	13	4	0	0	0	18
0715 - 0815	1	17	2	0	0	0	20
0730 - 0830	1	19	5	0	0	0	25
0745 - 0845	0	15	5	0	0	0	20
0800 - 0900	0	22	5	0	0	0	27
PEAK HR	1	19	5	0	0	0	25

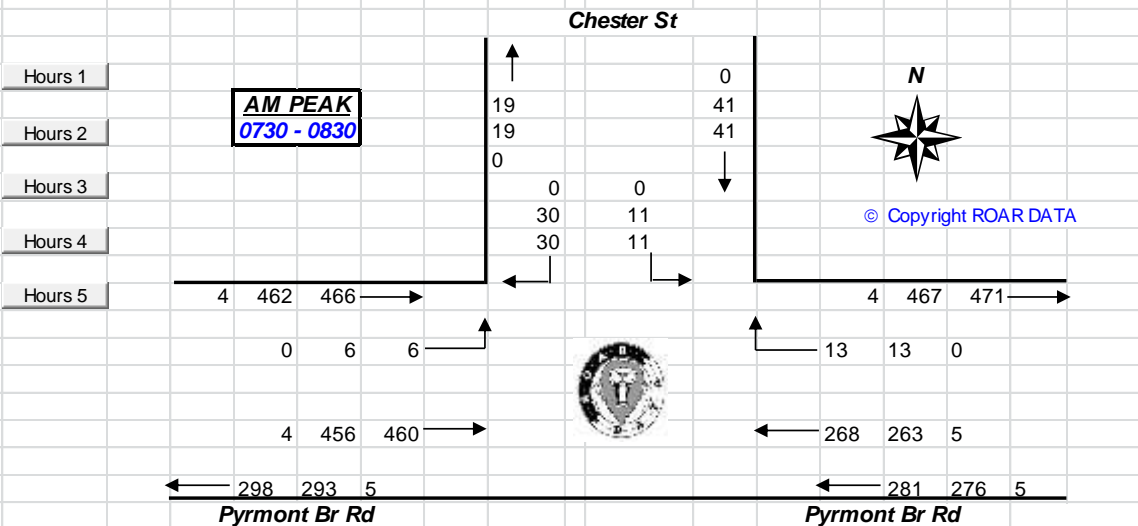

© Copyright ROAR DATA



R.O.A.R DATA

Reliable, Original & Authentic Results

Ph.88196847, Mob.0418-239019

Client : Varga Traffic Planning

Job No/Name : 6492 ANNANDALE Chester St

Day/Date : Tuesday 20th June 2017

AM

**TOTAL VOLUMES
FOR COUNT
PERIOD**



Chester St

47

0

47

77

0

77

11

920

931

11

924

935

Pymont Br Rd

Pymont Br Rd

← 544

536

8

← 518

510

8



R.O.A.R DATA

Reliable, Original & Authentic Results

Ph.88196847, Mob.0418-239019

Client : Varga Traffic Planning

Job No/Name : 6492 ANNANDALE Chester St

Day/Date : Tuesday 20th June 2017

AM

Chester St & Pymont Bridge Rd

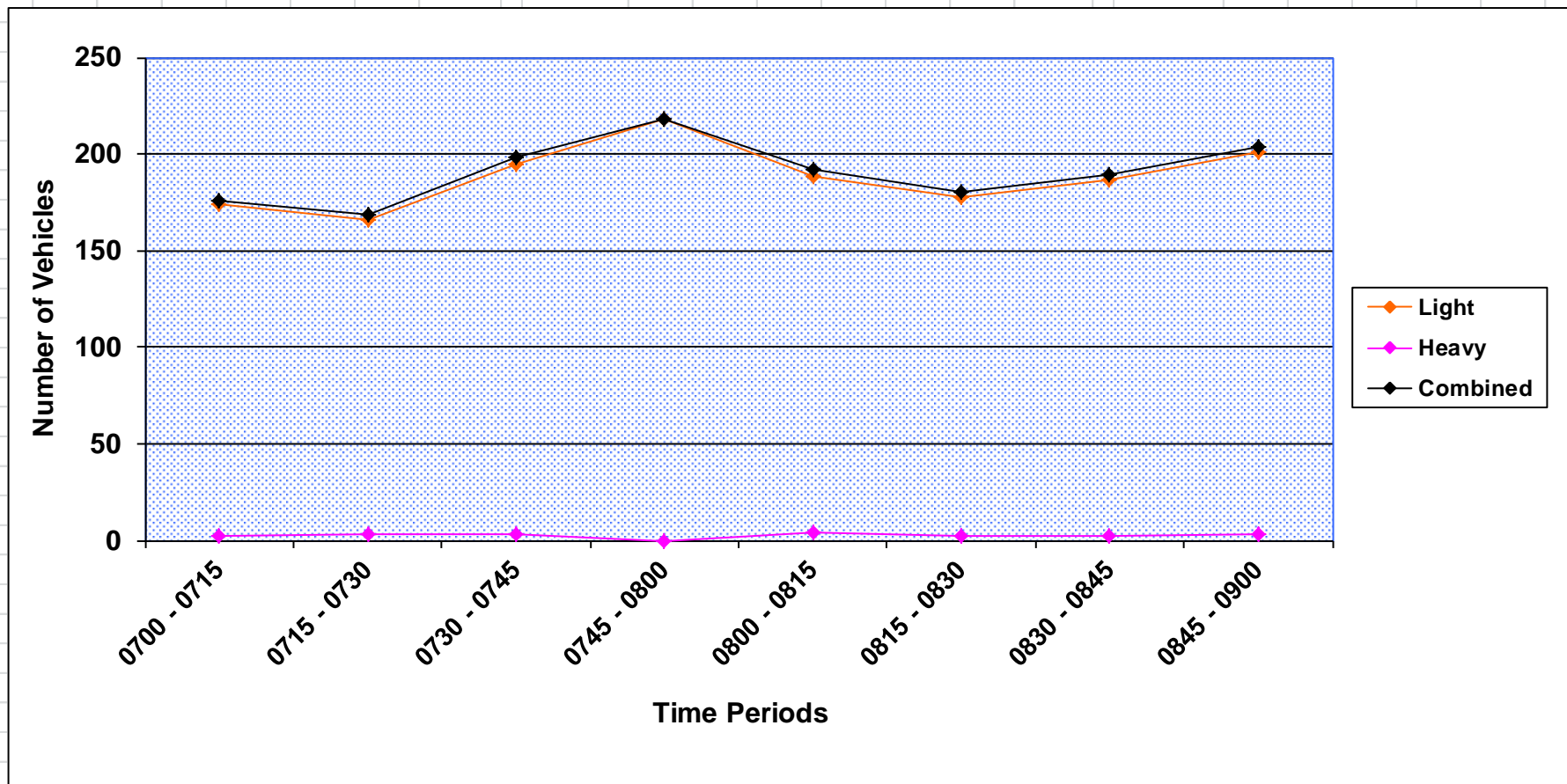



R.O.A.R. DATA

Reliable, Original & Authentic Results

Ph.88196847, Mob.0418-239019

Client : Varga Traffic Planning

Job No/Name : 6492 ANNANDALE Chester St

Day/Date : Tuesday 20th June 2017

Lights	WEST		NORTH		EAST		TOT
	Pymont Br		Chester St		Pymont Br		
Time Per	I	L	R	L	R	I	
1630 - 1645	67	2	7	3	7	141	227
1645 - 1700	69	2	7	10	5	126	219
1700 - 1715	91	6	15	16	1	164	293
1715 - 1730	74	3	8	5	3	152	245
1730 - 1745	79	2	6	4	5	131	227
1745 - 1800	84	2	17	7	3	157	270
1800 - 1815	69	6	5	5	6	156	247
1815 - 1830	64	1	4	9	5	152	235
Per End	597	24	69	59	35	1179	1963

Heavies	WEST		NORTH		EAST		TOT
	Pymont Br		Chester St		Pymont Br		
Time Per	I	L	R	L	R	I	
1630 - 1645	0	0	0	0	0	2	2
1645 - 1700	5	0	0	0	0	0	5
1700 - 1715	0	0	0	0	0	2	2
1715 - 1730	0	0	0	0	0	0	0
1730 - 1745	0	0	0	0	0	1	1
1745 - 1800	0	0	0	0	0	0	0
1800 - 1815	0	0	0	0	0	0	0
1815 - 1830	1	0	0	0	0	0	1
Per End	6	0	0	0	0	5	11

Combined	WEST		NORTH		EAST		TOT
	Pymont Br		Chester St		Pymont Br		
Time Per	I	L	R	L	R	I	
1630 - 1645	67	2	7	3	7	143	229
1645 - 1700	74	2	7	10	5	126	224
1700 - 1715	91	6	15	16	1	166	295
1715 - 1730	74	3	8	5	3	152	245
1730 - 1745	79	2	6	4	5	132	228
1745 - 1800	84	2	17	7	3	157	270
1800 - 1815	69	6	5	5	6	156	247
1815 - 1830	65	1	4	9	5	152	236
Per End	603	24	69	59	35	1184	1974

Lights	WEST		NORTH		EAST		TOT
	Pymont Br		Chester St		Pymont Br		
Peak Per	I	L	R	L	R	I	
1630 - 1730	301	13	37	34	16	583	984
1645 - 1745	313	13	36	35	14	573	984
1700 - 1800	328	13	46	32	12	604	1035
1715 - 1815	306	13	36	21	17	596	989
1730 - 1830	296	11	32	25	19	596	979

Heavies	WEST		NORTH		EAST		TOT
	Pymont Br		Chester St		Pymont Br		
Peak Per	I	L	R	L	R	I	
1630 - 1730	5	0	0	0	0	4	9
1645 - 1745	5	0	0	0	0	3	8
1700 - 1800	0	0	0	0	0	3	3
1715 - 1815	0	0	0	0	0	1	1
1730 - 1830	1	0	0	0	0	1	2

Combined	WEST		NORTH		EAST		TOT
	Pymont Br		Chester St		Pymont Br		
Peak Per	I	L	R	L	R	I	
1630 - 1730	306	13	37	34	16	587	993
1645 - 1745	318	13	36	35	14	576	992
1700 - 1800	328	13	46	32	12	607	1038
1715 - 1815	306	13	36	21	17	597	990
1730 - 1830	297	11	32	25	19	597	981

PEAK HR	328	13	46	32	12	604	1035
---------	-----	----	----	----	----	-----	------

PEAK HR	0	0	0	0	0	3	3
---------	---	---	---	---	---	---	---

PEAK HR	328	13	46	32	12	607	1038
---------	-----	----	----	----	----	-----	------

Peds	WEST		NORTH		EAST		TOT
	Pymont Br		Chester St		Pymont Br		
Time Per							
1630 - 1645	3		6		1		10
1645 - 1700	3		1		0		4
1700 - 1715	2		3		1		6
1715 - 1730	3		3		0		6
1730 - 1745	3		6		0		9
1745 - 1800	1		4		1		6
1800 - 1815	1		6		3		10
1815 - 1830	2		6		3		11
Per End	18		35		9		62

Peak Per	WEST		NORTH		EAST		TOT
	Pymont Br		Chester St		Pymont Br		
1630 - 1730	11		13		2		26
1645 - 1745	11		13		1		25
1700 - 1800	9		16		2		27
1715 - 1815	8		19		4		31
1730 - 1830	7		22		7		36
PEAK HR	9		16		2		27

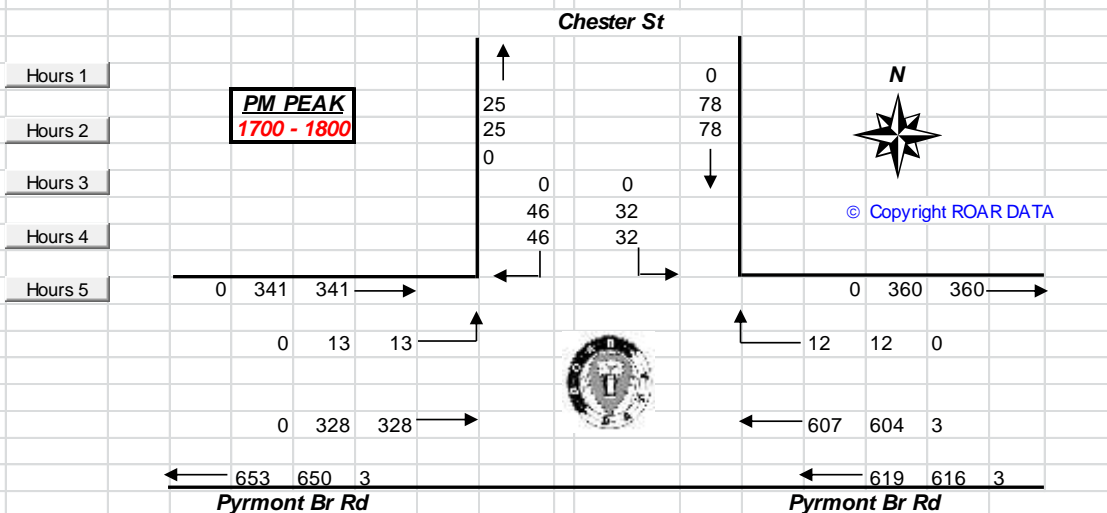



R.O.A.R DATA

Reliable, Original & Authentic Results

Ph.88196847, Mob.0418-239019

Client : Varga Traffic Planning

Job No/Name : 6492 ANNANDALE Chester St

Day/Date : Tuesday 20th June 2017

PM

**TOTAL VOLUMES
FOR COUNT
PERIOD**

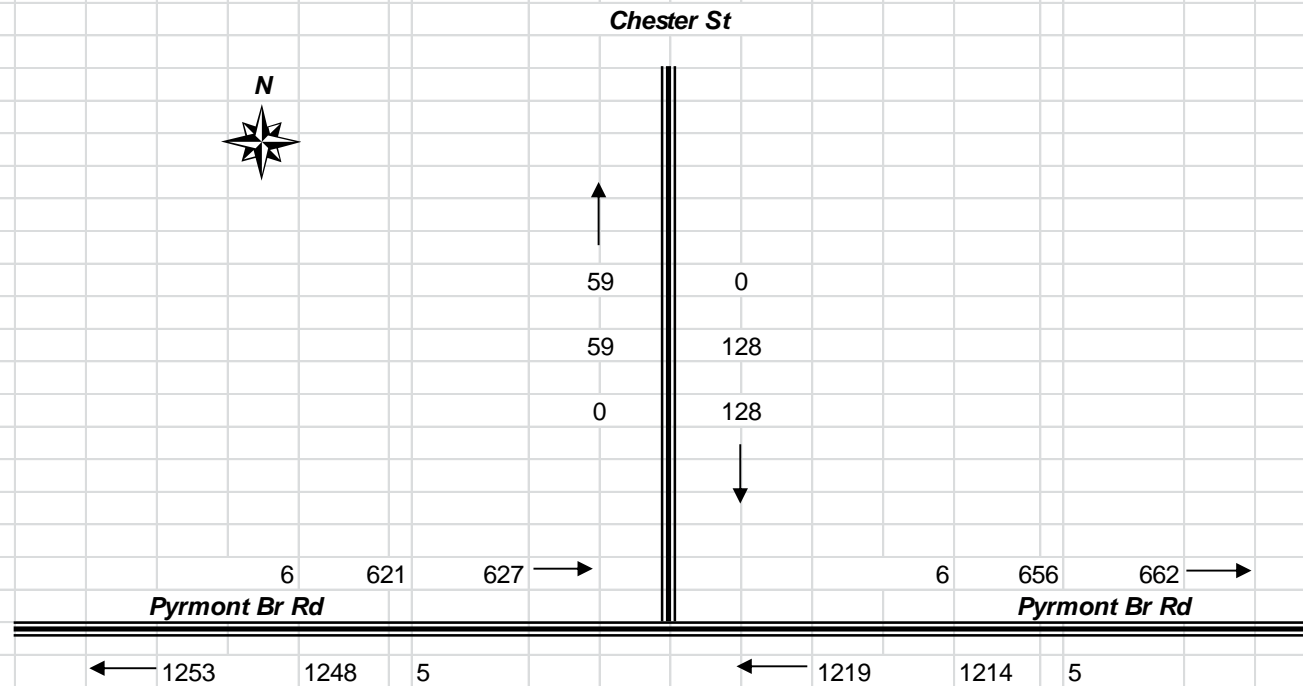



R.O.A.R DATA

Reliable, Original & Authentic Results

Ph.88196847, Mob.0418-239019

Client : Varga Traffic Planning

Job No/Name : 6492 ANNANDALE Chester St

Day/Date : Tuesday 20th June 2017

PM

Chester St & Pymont Bridge Rd

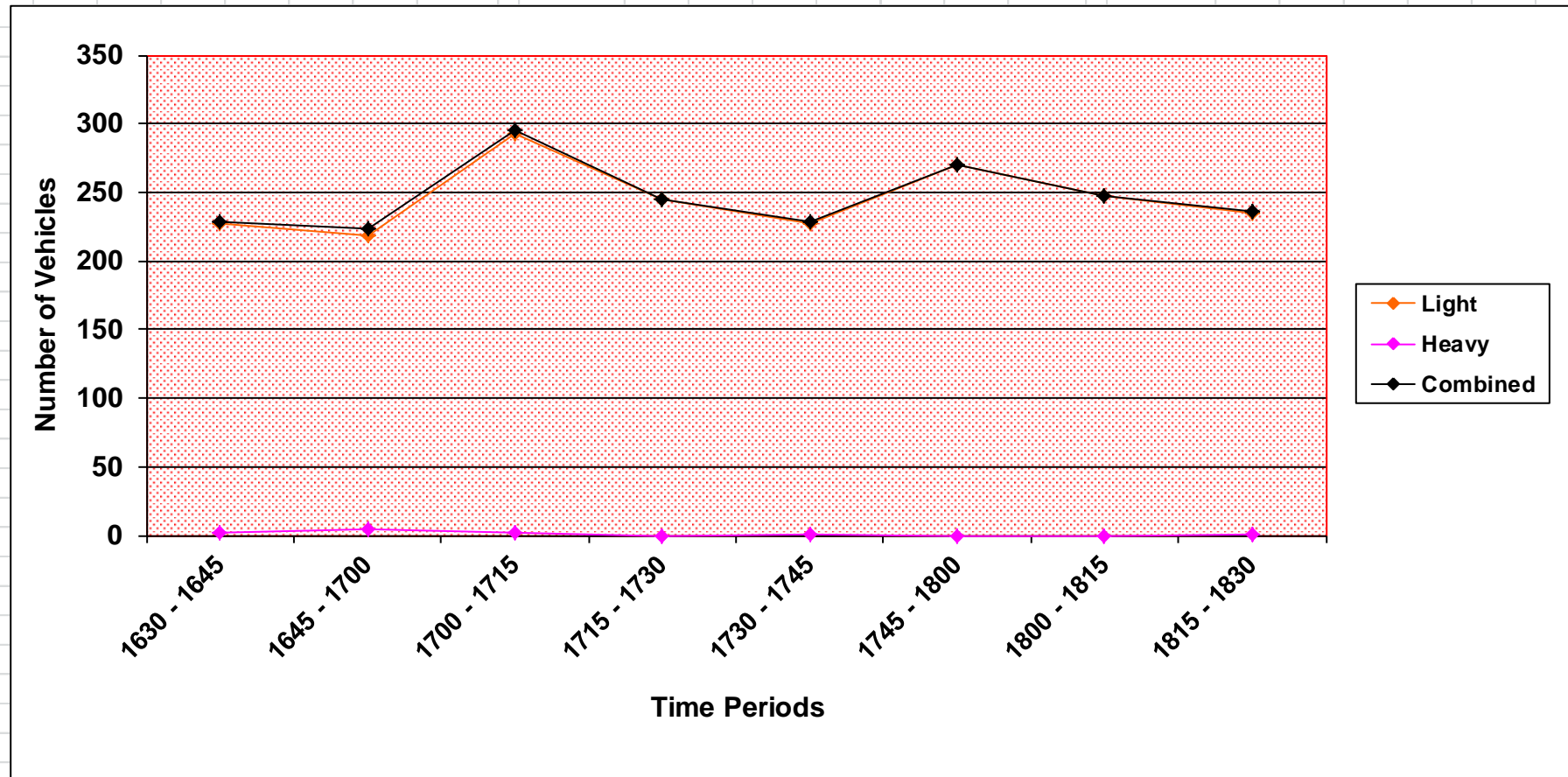



R.O.A.R. DATA

Reliable, Original & Authentic Results
Ph.88196847, Mob.0418-239019

Client : Varga Traffic Planning
Job No/Name : 6492 ANNANDALE Chester St
Day/Date : Tuesday 20th June 2017

Intersection Details

Obtained via satellite
May be incorrect

AM PEAK HOUR
0730 - 0830



Chester St

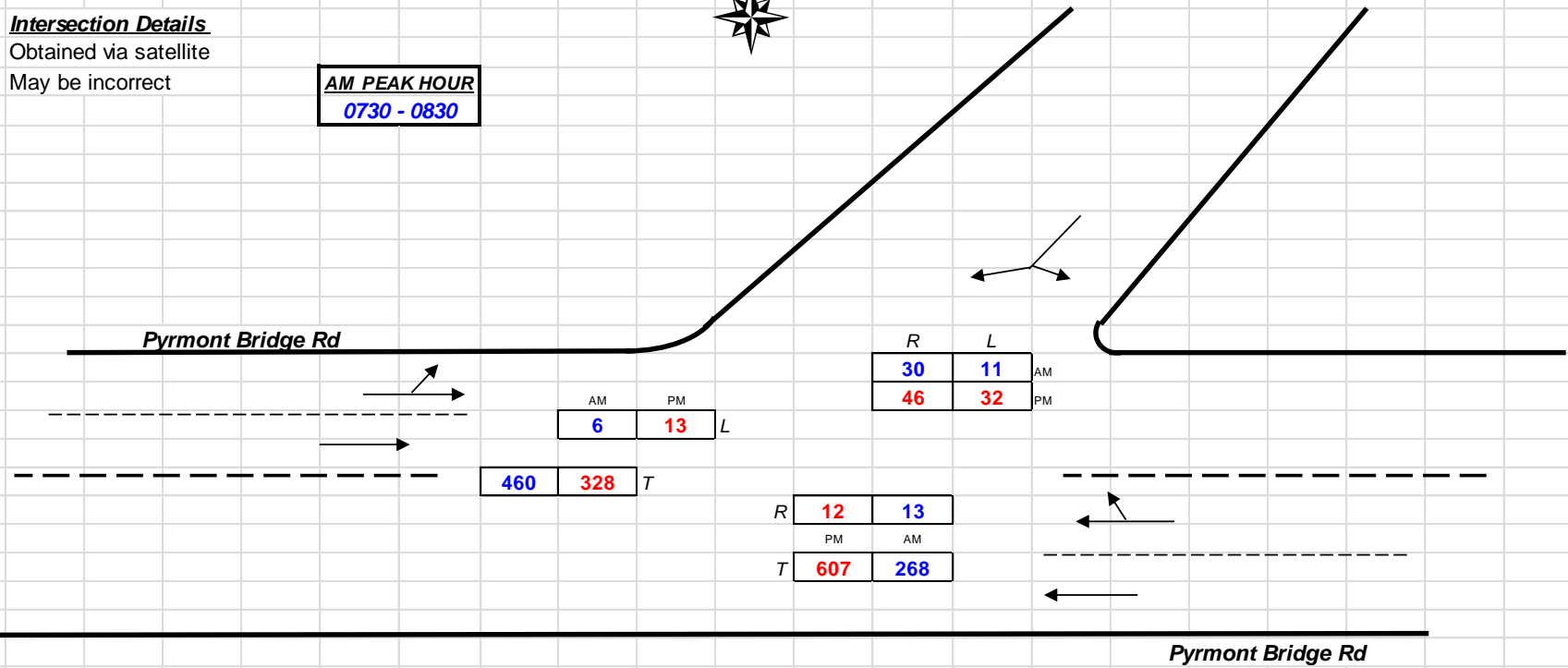

Combined Figures only

PM PEAK HOUR
1700 - 1800

Weather >>>





R.O.A.R. DATA

Reliable, Original & Authentic Results

Ph.88196847, Mob.0418-239019

Client : Varga Traffic Planning
 Job No/Name : 6492 ANNANDALE Chester St
 Day/Date : Tuesday 20th June 2017

Lights	NORTH		WEST		SOUTH		TOT
	Booth St		Guihen St		Booth St		
	I	R	L	R	L	I	
0700 - 0715	84	5	5	3	2	57	156
0715 - 0730	100	8	2	1	2	48	161
0730 - 0745	134	8	1	1	2	63	209
0745 - 0800	150	9	3	1	3	81	247
0800 - 0815	133	9	0	1	1	77	221
0815 - 0830	143	10	1	1	1	75	231
0830 - 0845	117	5	0	0	0	76	198
0845 - 0900	131	10	1	1	3	85	231
Per End	992	64	13	9	14	562	1654

Heavies	NORTH		WEST		SOUTH		TOT
	Booth St		Guihen St		Booth St		
	I	R	L	R	L	I	
0700 - 0715	2	0	0	0	0	1	3
0715 - 0730	3	0	0	0	0	1	4
0730 - 0745	8	0	0	0	0	1	9
0745 - 0800	4	0	0	0	0	2	6
0800 - 0815	6	0	0	0	0	1	7
0815 - 0830	6	0	0	0	0	2	8
0830 - 0845	5	0	0	0	0	1	6
0845 - 0900	5	0	0	0	0	4	9
Per End	39	0	0	0	0	13	52

Combined	NORTH		WEST		SOUTH		TOT
	Booth St		Guihen St		Booth St		
	I	R	L	R	L	I	
0700 - 0715	86	5	5	3	2	58	159
0715 - 0730	103	8	2	1	2	49	165
0730 - 0745	142	8	1	1	2	64	218
0745 - 0800	154	9	3	1	3	83	253
0800 - 0815	139	9	0	1	1	78	228
0815 - 0830	149	10	1	1	1	77	239
0830 - 0845	122	5	0	0	0	77	204
0845 - 0900	136	10	1	1	3	89	240
Per End	1031	64	13	9	14	575	1706

Lights	NORTH		WEST		SOUTH		TOT
	Booth St		Guihen St		Booth St		
	I	R	L	R	L	I	
0700 - 0800	468	30	11	6	9	249	773
0715 - 0815	517	34	6	4	8	269	838
0730 - 0830	560	36	5	4	7	296	908
0745 - 0845	543	33	4	3	5	309	897
0800 - 0900	524	34	2	3	5	313	881

Heavies	NORTH		WEST		SOUTH		TOT
	Booth St		Guihen St		Booth St		
	I	R	L	R	L	I	
0700 - 0800	17	0	0	0	0	5	22
0715 - 0815	21	0	0	0	0	5	26
0730 - 0830	24	0	0	0	0	6	30
0745 - 0845	21	0	0	0	0	6	27
0800 - 0900	22	0	0	0	0	8	30

Combined	NORTH		WEST		SOUTH		TOT
	Booth St		Guihen St		Booth St		
	I	R	L	R	L	I	
0700 - 0800	485	30	11	6	9	254	795
0715 - 0815	538	34	6	4	8	274	864
0730 - 0830	584	36	5	4	7	302	938
0745 - 0845	564	33	4	3	5	315	924
0800 - 0900	546	34	2	3	5	321	911

PEAK HR	560	36	5	4	7	296	908
----------------	------------	-----------	----------	----------	----------	------------	------------

PEAK HR	24	0	0	0	0	6	30
----------------	-----------	----------	----------	----------	----------	----------	-----------

PEAK HR	584	36	5	4	7	302	938
----------------	------------	-----------	----------	----------	----------	------------	------------

Peds	NORTH		WEST		SOUTH		TOT
	Booth St	Guihen St	Booth St	Booth St	Booth St		
0700 - 0715	1	6	2			9	
0715 - 0730	1	9	2			12	
0730 - 0745	0	7	0			7	
0745 - 0800	4	10	0			14	
0800 - 0815	1	11	1			13	
0815 - 0830	1	12	0			13	
0830 - 0845	3	4	1			8	
0845 - 0900	1	6	1			8	
Per End	12	65	7			84	

Peak Per	NORTH		WEST		SOUTH		TOT
	Booth St	Guihen St	Booth St	Booth St	Booth St		
0700 - 0800	6	32	4			42	
0715 - 0815	6	37	3			46	
0730 - 0830	6	40	1			47	
0745 - 0845	9	37	2			48	
0800 - 0900	6	33	3			42	
PEAK HR	6	40	1			47	

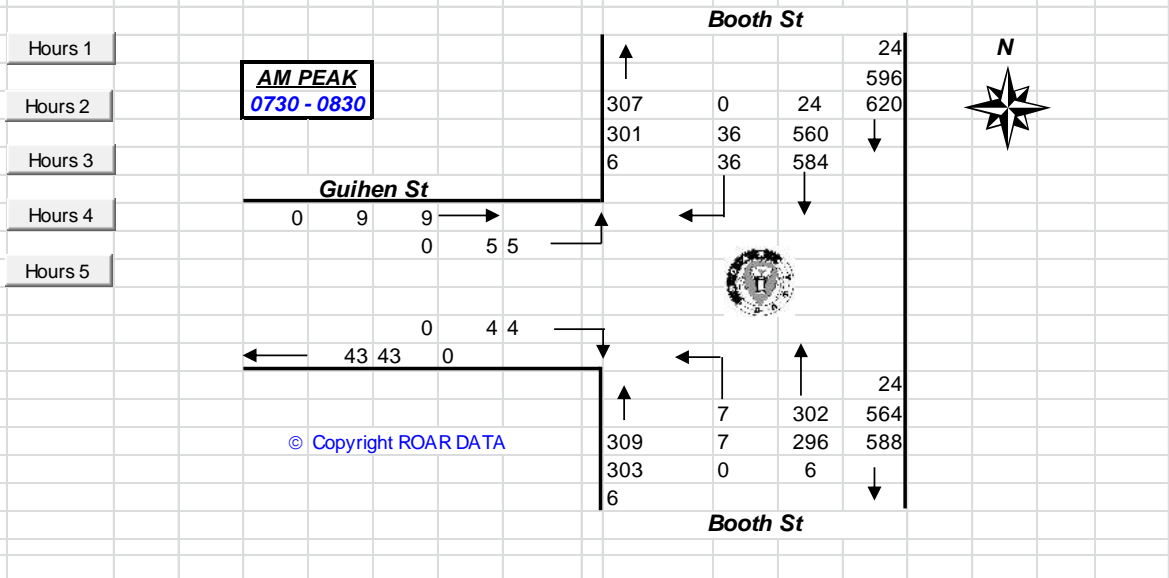



R.O.A.R DATA

Reliable, Original & Authentic Results

Ph.88196847, Mob.0418-239019

Client : Varga Traffic Planning

Job No/Name : 6492 ANNANDALE Chester St

Day/Date : Tuesday 20th June 2017

AM

TOTAL VOLUMES
FOR COUNT
PERIOD

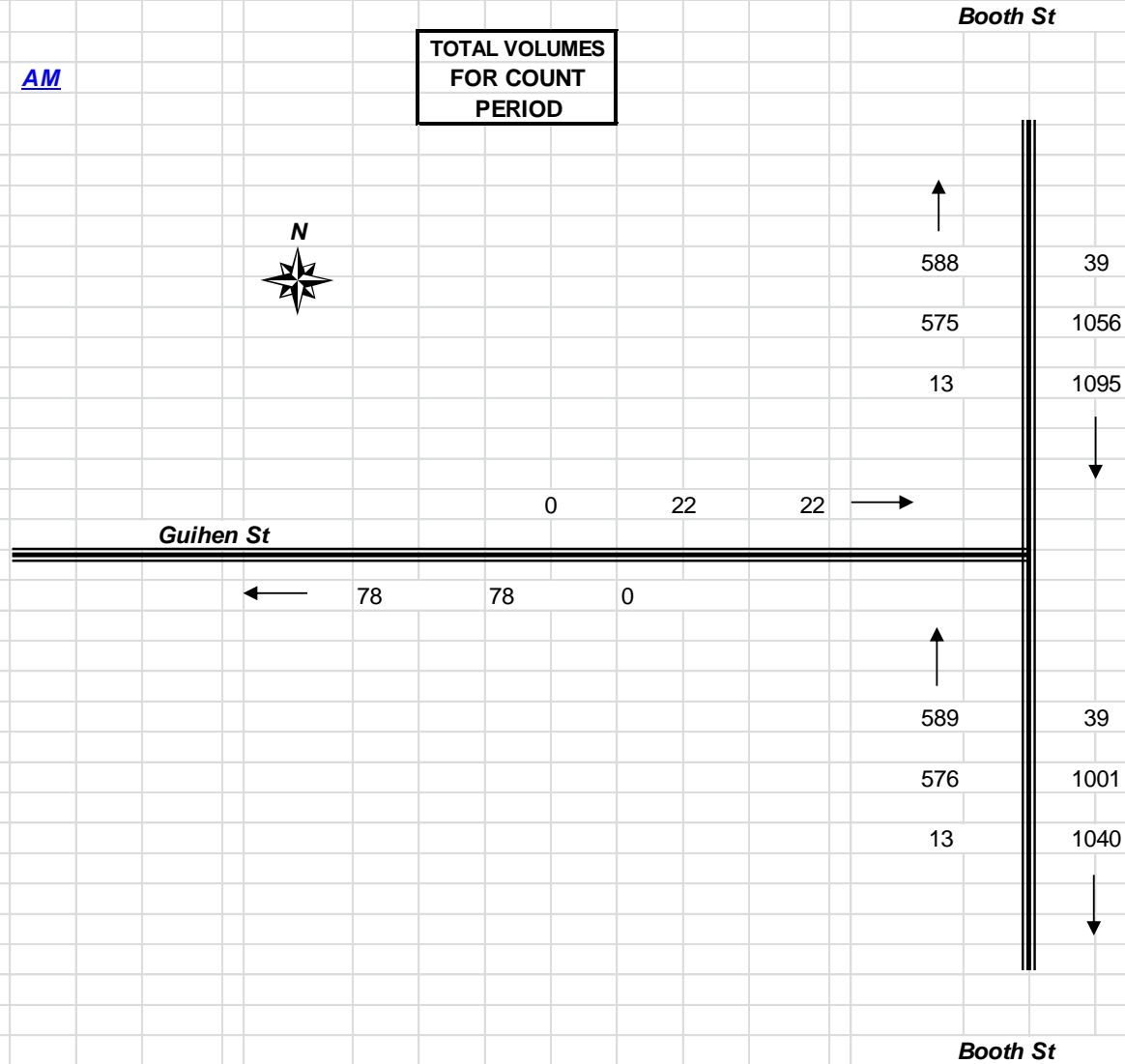



R.O.A.R DATA

Reliable, Original & Authentic Results

Ph.88196847, Mob.0418-239019

Client : Varga Traffic Planning

Job No/Name : 6492 ANNANDALE Chester St

Day/Date : Tuesday 20th June 2017

AM

Guihen St St & Booth St

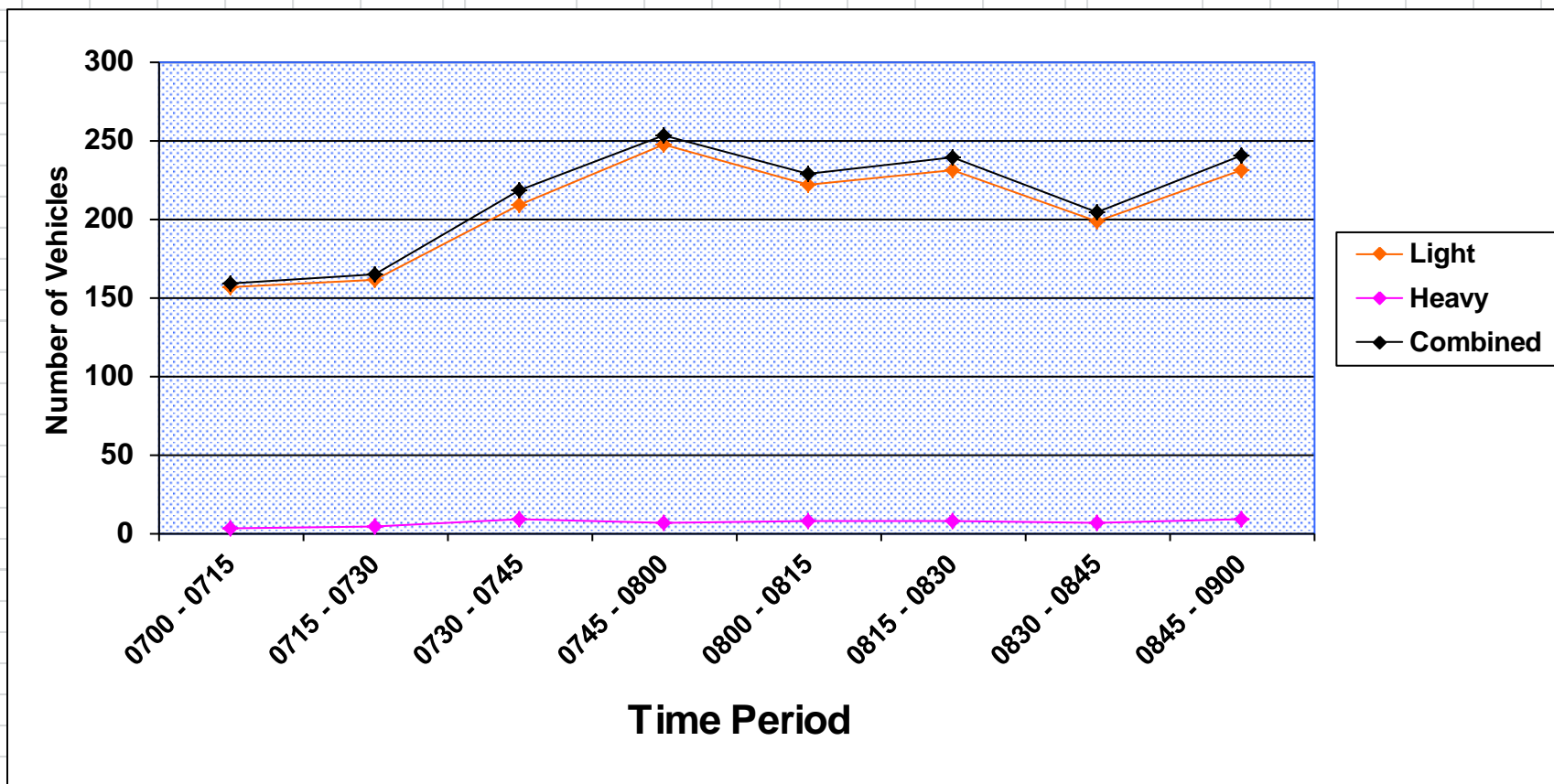



R.O.A.R. DATA

Reliable, Original & Authentic Results

Ph.88196847, Mob.0418-239019

Client : Varga Traffic Planning

Job No/Name : 6492 ANNANDALE Chester St

Day/Date : Tuesday 20th June 2017

Lights	NORTH		WEST		SOUTH		TOT
	Booth St	Booth St	Guihen St	Booth St	Booth St	Booth St	
Time Per	T	R	L	R	L	T	TOT
1630 - 1645	81	12	6	3	4	122	228
1645 - 1700	84	11	4	1	5	115	220
1700 - 1715	106	14	12	2	3	134	271
1715 - 1730	92	4	6	1	2	108	213
1730 - 1745	102	8	3	0	3	138	254
1745 - 1800	88	16	7	1	2	120	234
1800 - 1815	99	8	5	2	1	132	247
1815 - 1830	82	7	2	0	7	98	196
Per End	734	80	45	10	27	967	1863

Heavies	NORTH		WEST		SOUTH		TOT
	Booth St	Booth St	Guihen St	Booth St	Booth St	Booth St	
Time Per	T	R	L	R	L	T	TOT
1630 - 1645	2	0	0	0	0	2	4
1645 - 1700	3	0	0	0	0	5	8
1700 - 1715	0	0	0	0	0	3	3
1715 - 1730	1	0	0	0	0	3	4
1730 - 1745	2	0	0	0	0	2	4
1745 - 1800	0	0	0	0	0	5	5
1800 - 1815	1	0	0	0	0	4	5
1815 - 1830	1	0	0	0	0	3	4
Per End	10	0	0	0	0	27	37

Combined	NORTH		WEST		SOUTH		TOT
	Booth St	Booth St	Guihen St	Booth St	Booth St	Booth St	
Time Per	T	R	L	R	L	T	TOT
1630 - 1645	83	12	6	3	4	124	232
1645 - 1700	87	11	4	1	5	120	228
1700 - 1715	106	14	12	2	3	137	274
1715 - 1730	93	4	6	1	2	111	217
1730 - 1745	104	8	3	0	3	140	258
1745 - 1800	88	16	7	1	2	125	239
1800 - 1815	100	8	5	2	1	136	252
1815 - 1830	83	7	2	0	7	101	200
Per End	744	80	45	10	27	994	1900

Lights	NORTH		WEST		SOUTH		TOT
	Booth St	Booth St	Guihen St	Booth St	Booth St	Booth St	
Peak Per	T	R	L	R	L	T	TOT
1630 - 1730	363	41	28	7	14	479	932
1645 - 1745	384	37	25	4	13	495	958
1700 - 1800	388	42	28	4	10	500	972
1715 - 1815	381	36	21	4	8	498	948
1730 - 1830	371	39	17	3	13	488	931
PEAK HR	388	42	28	4	10	500	972

Heavies	NORTH		WEST		SOUTH		TOT
	Booth St	Booth St	Guihen St	Booth St	Booth St	Booth St	
Peak Per	T	R	L	R	L	T	TOT
1630 - 1730	6	0	0	0	0	13	19
1645 - 1745	6	0	0	0	0	13	19
1700 - 1800	3	0	0	0	0	13	16
1715 - 1815	4	0	0	0	0	14	18
1730 - 1830	4	0	0	0	0	14	18
PEAK HR	3	0	0	0	0	13	16

Combined	NORTH		WEST		SOUTH		TOT
	Booth St	Booth St	Guihen St	Booth St	Booth St	Booth St	
Peak Per	T	R	L	R	L	T	TOT
1630 - 1730	369	41	28	7	14	492	951
1645 - 1745	390	37	25	4	13	508	977
1700 - 1800	391	42	28	4	10	513	988
1715 - 1815	385	36	21	4	8	512	966
1730 - 1830	375	39	17	3	13	502	949
PEAK HR	391	42	28	4	10	513	988

Peds	NORTH		WEST		SOUTH		TOT
	Booth St	Booth St	Guihen St	Booth St	Booth St	Booth St	
Time Per	Booth St	Booth St	Guihen St	Booth St	Booth St	Booth St	TOT
1630 - 1645	0		11		2		13
1645 - 1700	1		16		4		21
1700 - 1715	2		33		5		40
1715 - 1730	0		15		2		17
1730 - 1745	3		19		1		23
1745 - 1800	1		25		2		28
1800 - 1815	2		8		1		11
1815 - 1830	0		20		2		22
Per End	9		147		19		175

Peak Per	NORTH		WEST		SOUTH		TOT
	Booth St	Booth St	Guihen St	Booth St	Booth St	Booth St	
1630 - 1730	3		75		13		91
1645 - 1745	6		83		12		101
1700 - 1800	6		92		10		108
1715 - 1815	6		67		6		79
1730 - 1830	6		72		6		84
PEAK HR	6		92		10		108

- Hours 1
- Hours 2
- Hours 3
- Hours 4
- Hours 5

PM PEAK
1700 - 1800

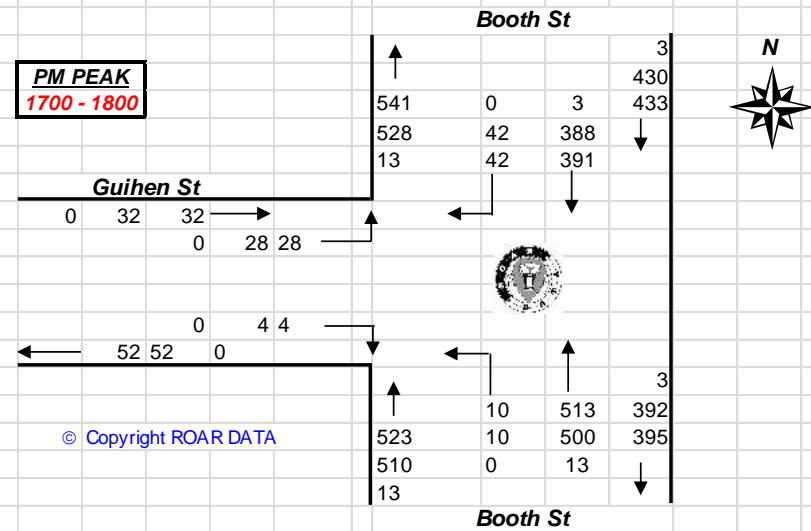

© Copyright ROAR DATA



R.O.A.R DATA

Reliable, Original & Authentic Results
Ph.88196847, Mob.0418-239019

Client : Varga Traffic Planning

Job No/Name : 6492 ANNANDALE Chester St

Day/Date : Tuesday 20th June 2017

PM

TOTAL VOLUMES
FOR COUNT
PERIOD

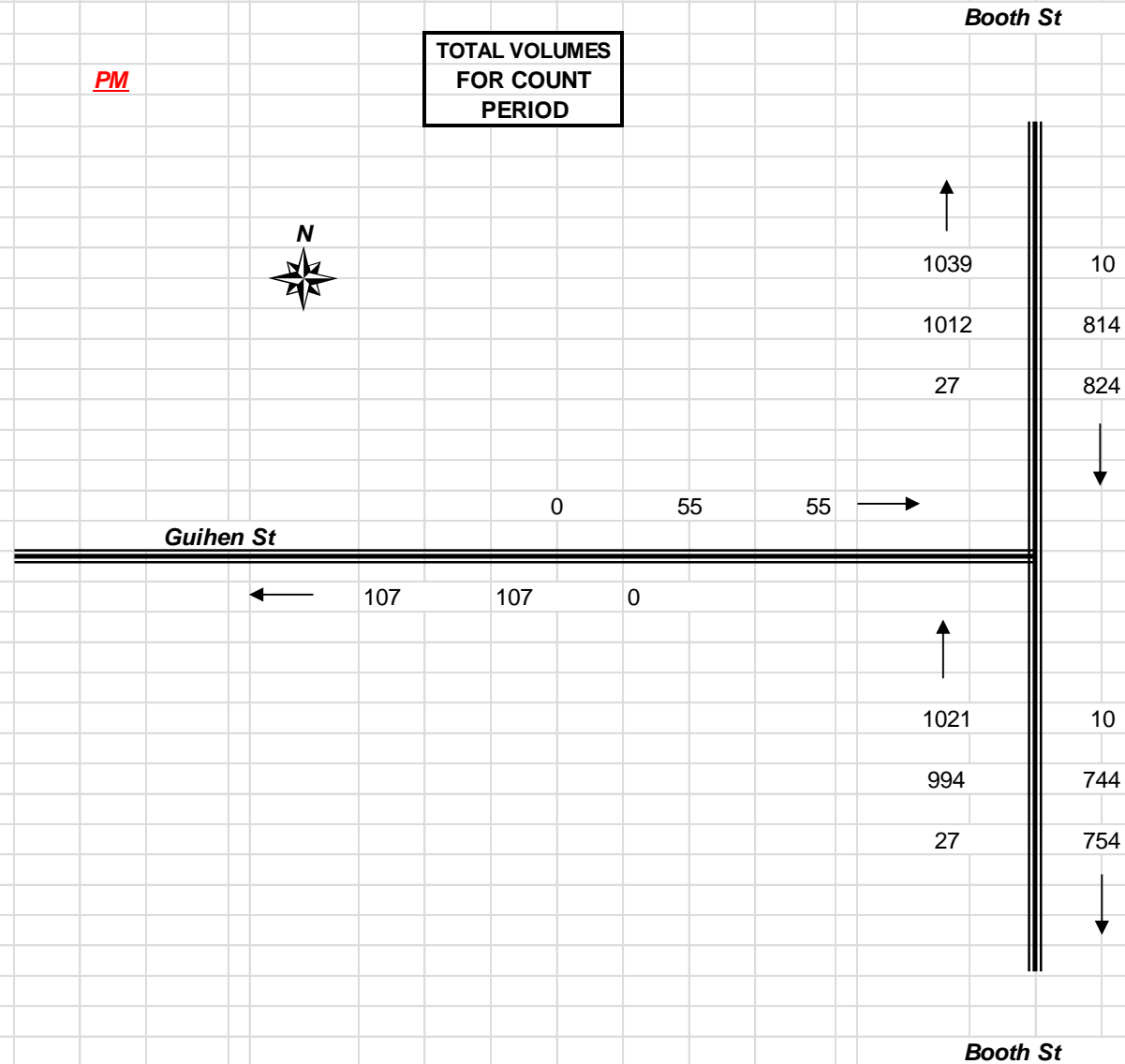



R.O.A.R DATA

Reliable, Original & Authentic Results

Ph.88196847, Mob.0418-239019

Client : Varga Traffic Planning

Job No/Name : 6492 ANNANDALE Chester St

Day/Date : Tuesday 20th June 2017

PM

Guihen St St & Booth St

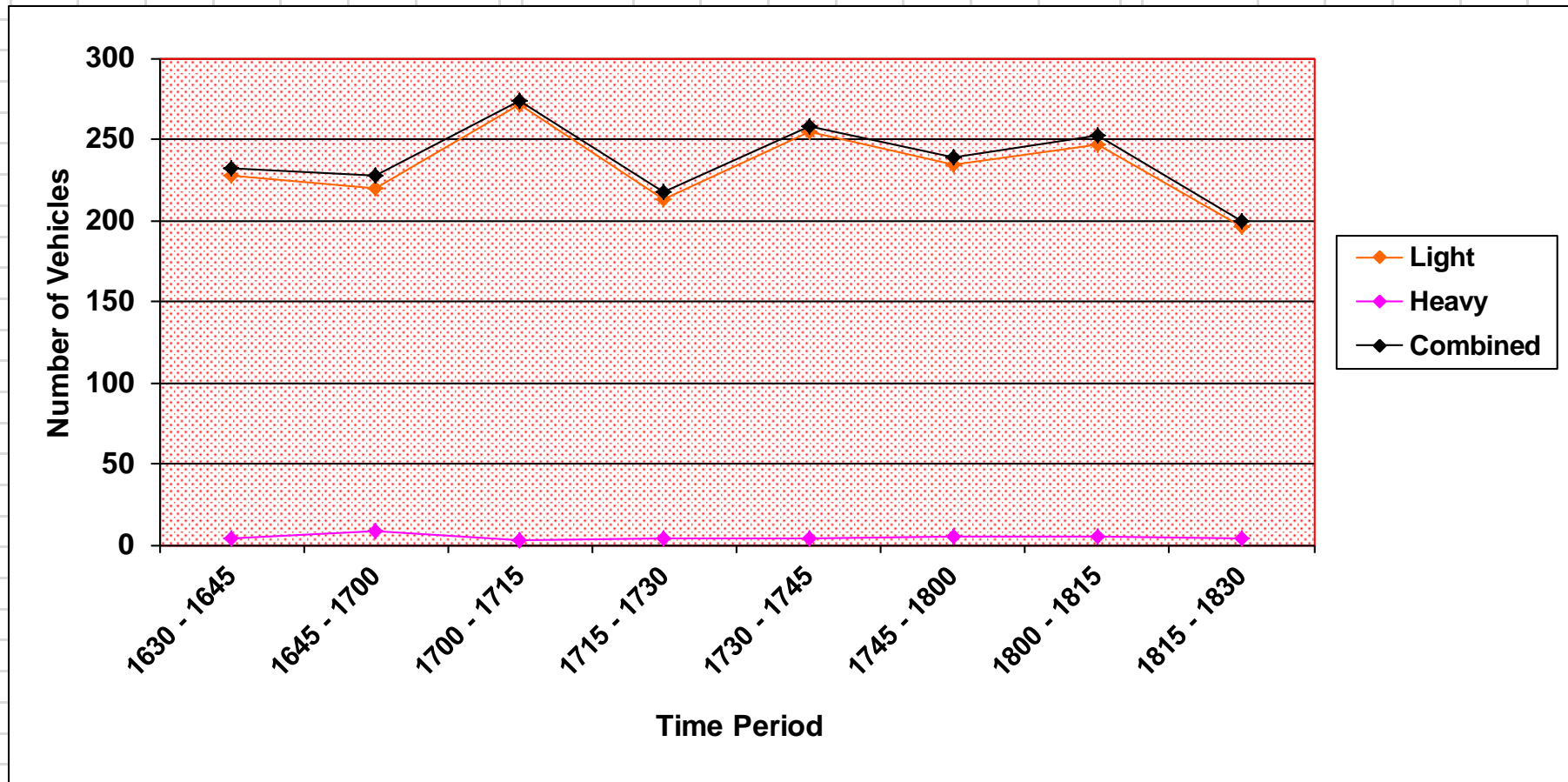



R.O.A.R. DATA

Reliable, Original & Authentic Results

Ph.88196847, Mob.0418-239019

Client : Varga Traffic Planning
Job No/Name : 6492 ANNANDALE Chester St
Day/Date : Tuesday 20th June 2017

Intersection Layout

Obtained via satellite

May be incorrect

No signage or line markings

AM PEAK HOUR
0730 - 0830



Booth St

Guihen St

R	T	
36	584	PM
42	391	AM

5	28	L
4	4	R
		AM
		PM

PM	10	513
AM	7	302
	L	T

PM PEAK HOUR
1700 - 1800

Combined Figures only

Weather >>>



Booth St

29 April 2109

Alex Sicari
Britely Property
Level 2, 210 Clarence St
Sydney, NSW, 2000

Via email: asicari@britely.com.au

Dear Alex,

Re: Car and Motorbike Parking for Purpose Built Student Accommodation

As discussed, please find below current and recommended arrangements for car and motorbike parking for quality student accommodation facilities like your proposed project located at 1-5 Chester St Camperdown.

UniLodge is a specialist student accommodation operator and manager with over 20 years' experience, over 20,000 beds under management across over 70 properties throughout Australasia.

For your project with approximately 90 dwellings and 90 beds, we would recommend the following as more than sufficient car and motorbike parking arrangements to operate the building.

In our experience for a building of this size, we would see car and motorbike parking as not used and unnecessary. The location of the site, its proximity to UNSW and Sydney CBD Universities via the new light rail would mean that very little if any students would own and use a car or motorbike. In fact, in our experience car, motorbike and bicycle usage is relatively low for this type of building in an inner city, highly accessible location. In the subject location, students will tend to walk and use public transport.

Across our portfolio we have many buildings that operate successfully with nil cars. A small selection of comparable properties with larger bed numbers and nil cars is included below:

- UniLodge Kensington, 233 beds, 48 cars spaces with none occupied by students.
- UniLodge Broadway. 585 beds, 154 cars spaces with 5 occupied by students.
- UniLodge Victoria University, 522 Beds, Nil cars.
- UniLodge Uni of Melbourne Royal Parade, 285 Beds, Nil cars.
- UniLodge on Swanston], 214 Beds, Nil cars.
- UniLodge D1 83 Beds, Nil cars.
- UniLodge D2 122 Beds, Nil cars.
- UniLodge @ Melbourne, 312 Beds, Nil cars.

We survey our students bi-annually. Negative feedback from our students with regard to nil car parking provisions is rare. Motorbike and bicycle parking for metro located projects is minimal.

In our view nil car parking provision, five motorbike bays and some bicycle parking is more than adequate to successfully manage the subject property.

Should you require additional information please do not hesitate to contact me accordingly.

Regards



Keith Hout
Senior Project Manager
UniLodge, Australia